

Sez. A-A

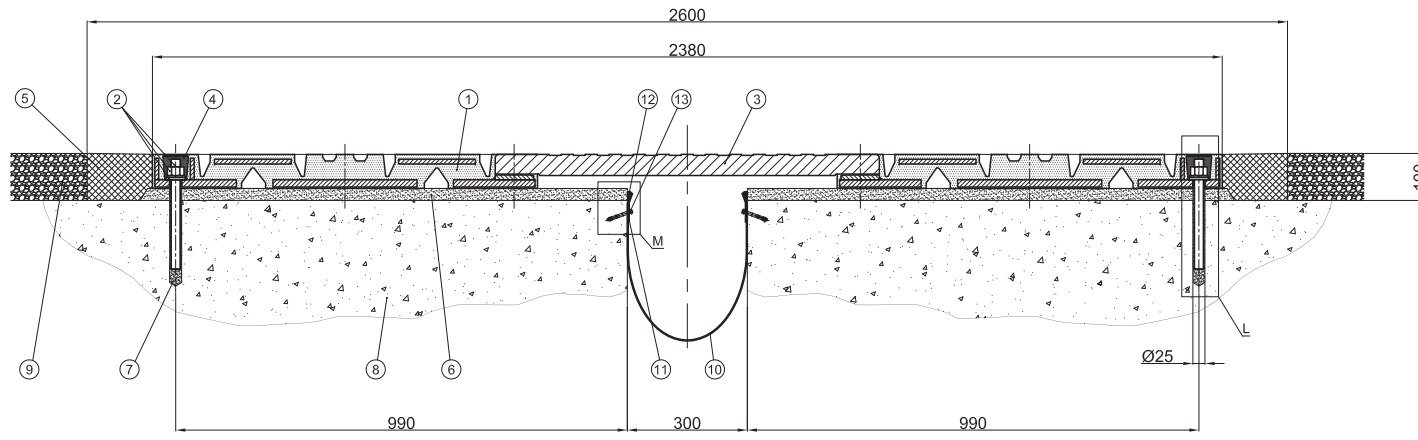

Detail 'M'

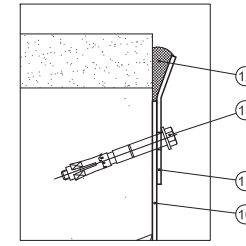

Detail 'H'

Assonometric

Detail 'G'

Assonometric

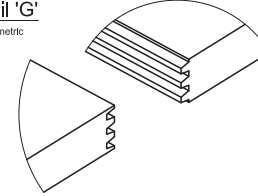

Section 'C-C'

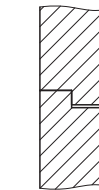

Detail 'L'

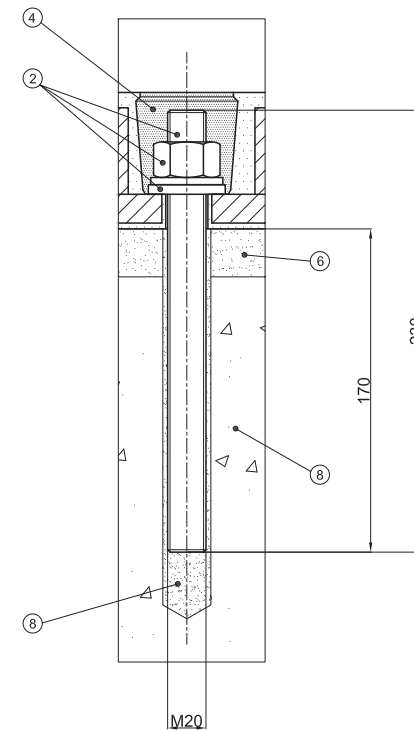

Plan view:
example of installation scheme

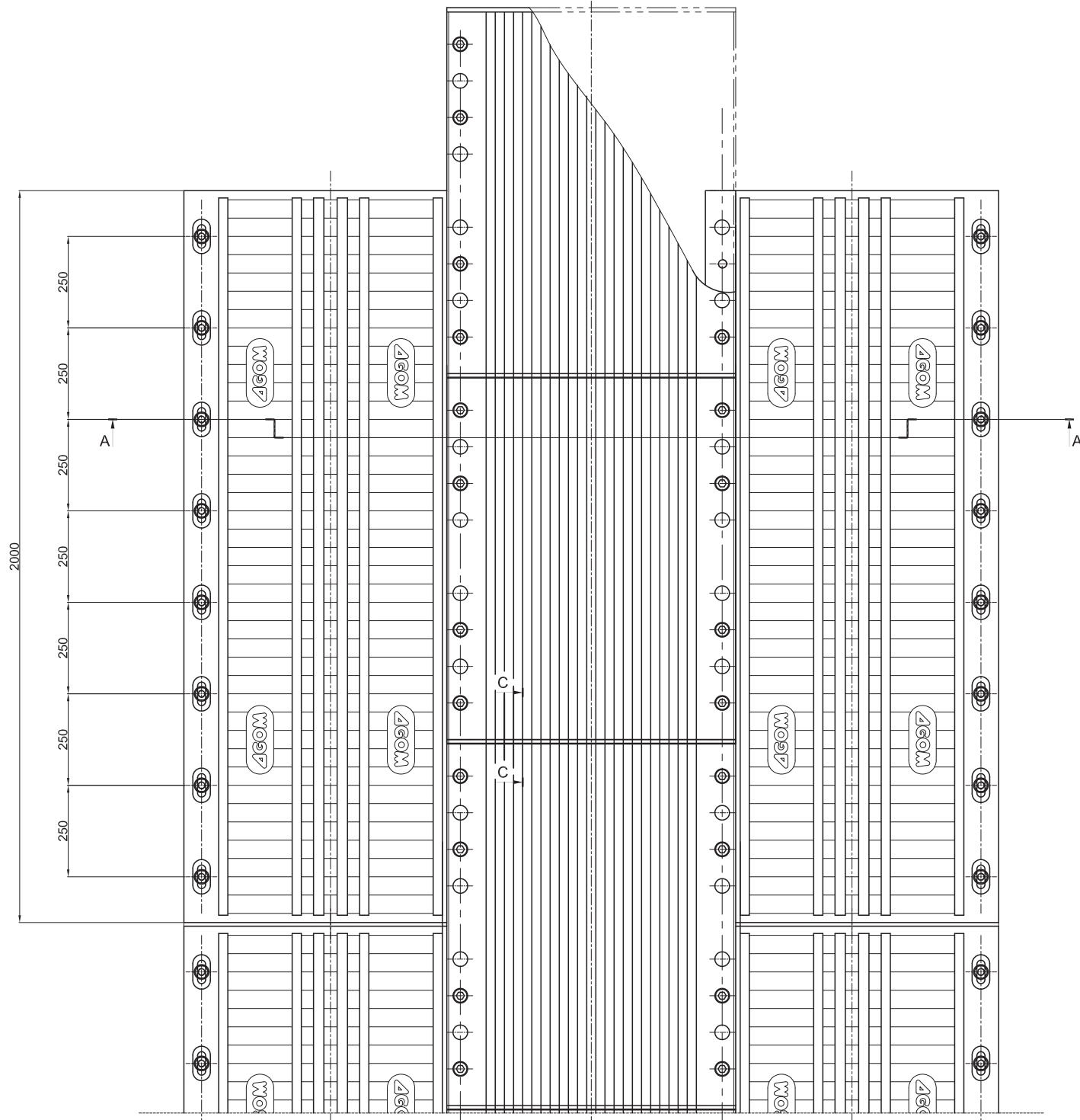
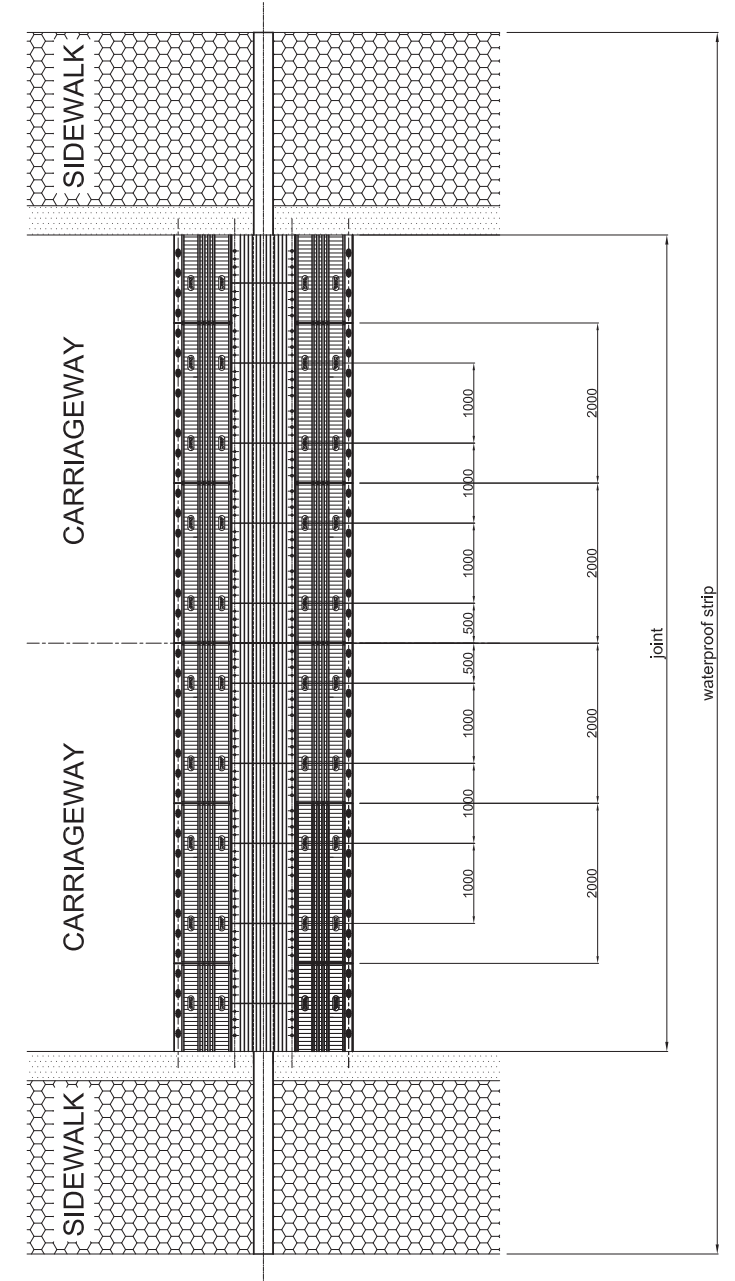

Type	Position	Service Longitudinal Movement [mm]	Weight [kg/m]
AGFLEXBJ 500	-	-250 / +250	505

(*) not supplied by AGOM, equivalent materials are allowable

POS.	DESCRIPTION	NOTES	STANDARD	MATERIAL
13	Fixing anchor M6	-	-	Hilti HST / HSA / HLC
12	Sealer	(*)	-	Silicon
11	Fixing Steel Plate	-	EN 10025	S235JR
10	Waterproof strip	-	-	PVC coated fabric
9	Asphalt	-	-	-
8	Concrete	-	-	-
7	Anchor Bar Grouting	-	-	Kimitech EP-AR
6	Bedding Mortar	(*)	-	BASF Masterflow 524
5	Transition Strip	(*)	-	BASF Wabocrete II
4	Bolt Hole Sealer	-	-	Tecnoseal 88
3	Plate	-	EN 10025	S355JR zinc coated
2	Anchor Bars M20 + Washers + Nuts	-	EN 20898	Cl. 8.8 Zinc Plated Steel
1	Expansion Joint	-	CNR 10018	Rubber 60 ShA + Steel

DATE	OBJECT	REVISION
16/12/2014	FIRST ISSUE	00

AGOM	AGOM INTERNATIONAL S. r.l.	DISEGNO N°
	Via Mesero, 12 20010 Ossona (MI)	01657

LA PROPRIETÀ DI QUESTO DISEGNO È RISERVATA A TERMI DI LEGGE. È VIETATO QUINDI RIPRODURLO O RENDERSLO NOTO A TERZI.