



# CANTILEVER STEEL JOINTS

## **AGOM INTERNATIONAL SRL**

Via Mesero, 12 - 20010 Ossona (MI) - Italy - [www.agom.it](http://www.agom.it)  
PH.: +39 02 9029111 - FAX: +39 02 9010201 - [agom@agom.it](mailto:agom@agom.it)

## *Building and engineering*

Bridges are subjected to movements and rotation caused by traffic, temperature changes, earthquakes, shrinkage, post-tensioning, creep, etc. Bridge construction requires carefully designed and manufactured bearings, anti-seismic devices, shock absorbers and expansion joints to ensure that such forces are properly dealt with throughout the life of the structure.

AGOM has over 50 years experience in design and manufacturing of bridge bearings, bridge expansion joints, anti-seismic devices and shock absorbers for the bridge-building and construction industry. All products comply with the latest European standards and all main international standards.



The quality and durability of these products are ensured by:

- our team of skilled engineers to conceptualise and design the most appropriate engineering solutions
- qualified professionals trained and continually updated in quality production techniques
- virgin raw materials that are quality assessed in our on-site testing laboratory
- ISO 9001:2008 quality standard accreditation
- strict quality control processes
- periodical external inspections by globally recognized bodies such as the Polytechnic University of Milan and Certiquality

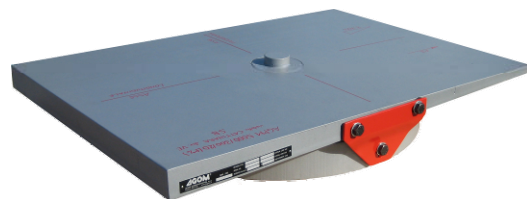

## *Bridge Deck Movements*

The horizontal movements of a bridge superstructure are due to :

- Temperature expansion and contraction
- Shrinkage of concrete
- Shortening of concrete due to creep effect
- Elastic shortening
- Movements due to induced external loads (e.g. earthquake, wind, vehicular braking etc.)



### Temperature

Temperature variations cause both expansion and shortening of the bridge deck and are usually computed as a plus and minus range about a mean structure temperature which occurs when the superstructure is placed on the bearings. Temperature differentials also occur in the deck from top to bottom and from one side to other side of the deck. Temperature differentials through the depth of the deck have little effect on the bearings and piers but those from one side of the deck to the other cause the deck to bend in plan which results in horizontal forces on the bearings and piers.

### Shrinkage of concrete

Shrinkage of concrete results in the shortening of the bridge superstructure. This effect depends upon factors such as quality of concrete used, size of the member, relative humidity and time after casting.

### Shortening due to creep effect

Effect of creep of concrete under post-tensioning and other permanent loads results in the shortening of the superstructure. It is a time dependent effect.

### Elastic shortening

This phenomenon occurs in case of pre-stressed superstructure during post-tensioning. The amount of shortening depends on the stage at which the superstructure is placed on the bearings and also at what stage it is post-tensioned. Sometimes, partial or complete tensioning may be carried out before the superstructure is placed on the bearings thus eliminating this shortening from affecting the bearings at least partly.

### *AGFJ cantilever metallic joints*

AGFJ steel expansion joint elements are specially designed and manufactured for traffic safety in accordance with ETAG n.32.

The gap between structures is overpassed by steel cantilever, finger shape elements that intersect, thus reducing the voids to small spaces.

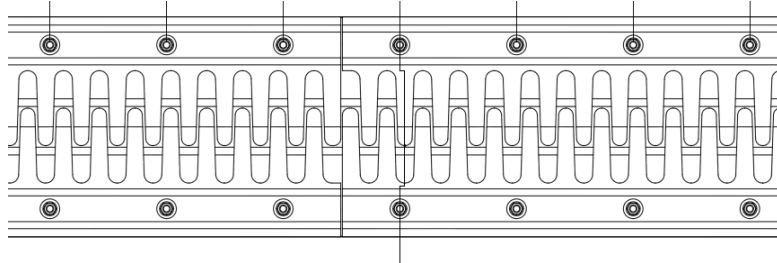

Steel elements are fixed to reinforced concrete using suitable corrosion-resistant galvanized anchor bolts to absorb elastic reactions, mechanical vibrations and other movements of the structure. For the larger joints (from AGFJ 150 included) folded steel plates, to be used also as formworks, are supplied together with the finger elements to allow an easier installation (see picture here below).



A waterproof strip is put below the steel elements to collect water and bring it towards the draining pipes.

AGFJ series are intended for vehicles traffic.

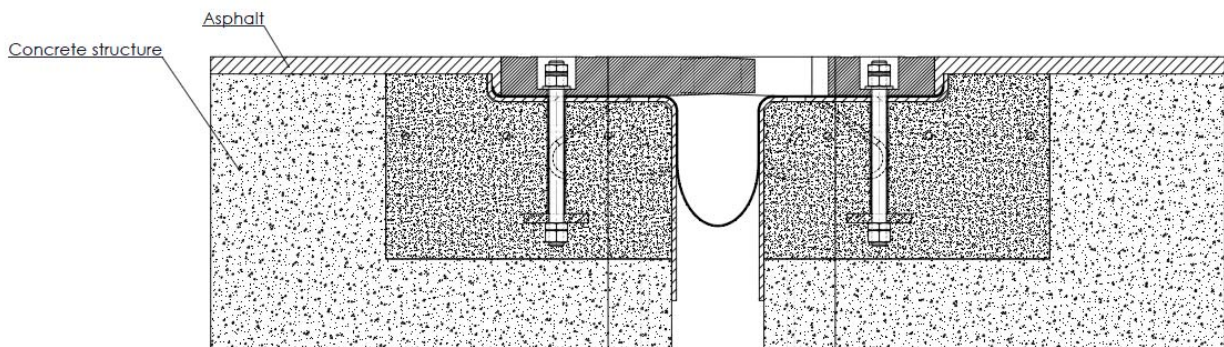

*Typical current section*



**Features**

AGFJ expansion joints has the following main characteristics:

- movement capacity from ±25 mm up to ±400 mm;
- structural elements from steel S355JR EN10025 galvanised or S355J0W EN10155;
- galvanised anchors with self-locking nuts;
- continuous watertight strip system;
- smooth transit over the expansion joints;
- footpath cover plates can be provided if required;
- vertical misalignment can be compensated during installation.

So their benefits can be summarized as below.

Feature	Benefit
Quality	Made of high resistance certificated materials.
Efficiency	Minimal maintenance requirements.
Skid Resistance	Each steel element is provided with surface grooves which allow for proper water drainage.
Low Noise	Special design reduces the noise while vehicles pass over it.
Long Service Life	Designed for heavy traffic.

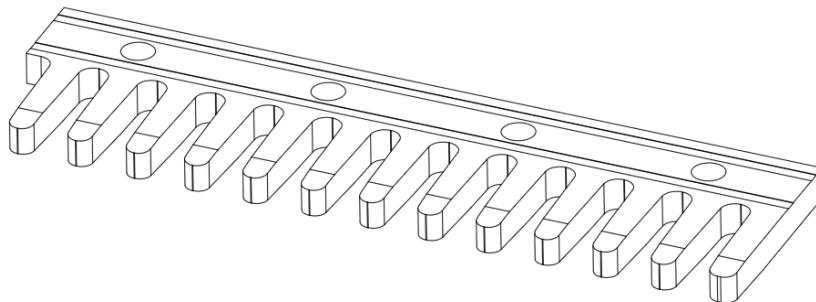

**Dimensions**

AGFJ expansion joints are supplied in standard elements with length about 1 m and has the following dimensions:

Model	Movement (mm)	Installation Gap (mm)	Width of top surface* (mm)	Anchor bars	Anchor bars spacing (mm)
AGJF 50	±25	60	290	M12x200	250
AGJF 100	±50	80	385	M16x200	250
AGJF 150	±75	100	470	M16x200	250
AGJF 250	±125	150	650	M20x230	252
AGJF 400	±200	230	935	M24x300	246
AGJF 550	±275	310	1235	M27x300	246
AGJF 800	±400	430	1713	M27x300	164

\*at installation, in average position



## Installation

The following installation procedure is very important and shall be fully read and understood prior to beginning any works. To ensure proper installation and performance of expansion joint system the following actions must be complied by skilled people. Errors during installation will affect product warranty.

- a) Read and understand installation procedure.
- b) Inspect all the materials supplied.
- c) Inspect the adjacent concrete structure for acceptance before beginning works.
- d) Study and verify the shop drawings.

### 1. Preparation of the joint zone.

Scarify the concrete deck near the joint edges, according to the dimensions suggested in AGOM drawings. Prepare the reinforcement bars in the zone where joint will be anchored.

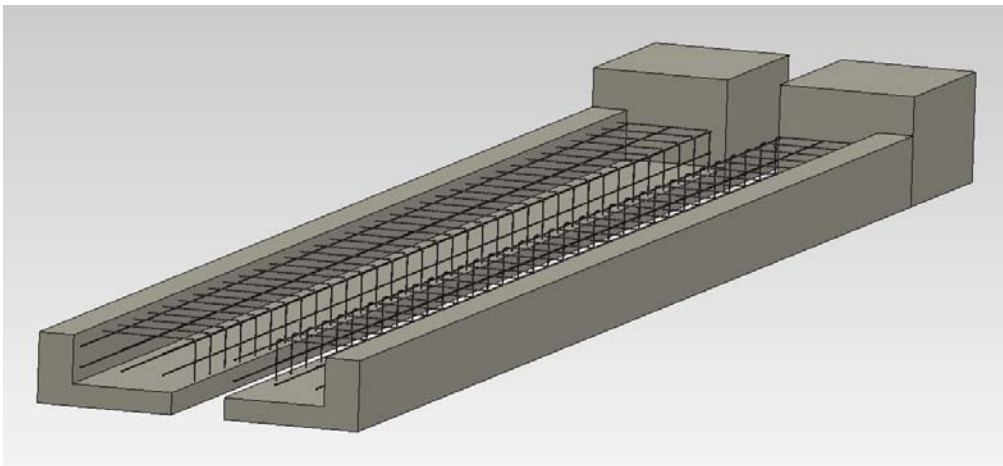

### 2. Preparation of the joint line.

By using steel plates, countersunk screws and nuts, connect the steel plates that will function as formworks. For the smaller joints (AGFJ 100 included), finger elements are supplied already connected with an angular steel plate and with the opposite elements. For the larger joints, the formworks will be connected directly to temporary steel beams to allow positioning.

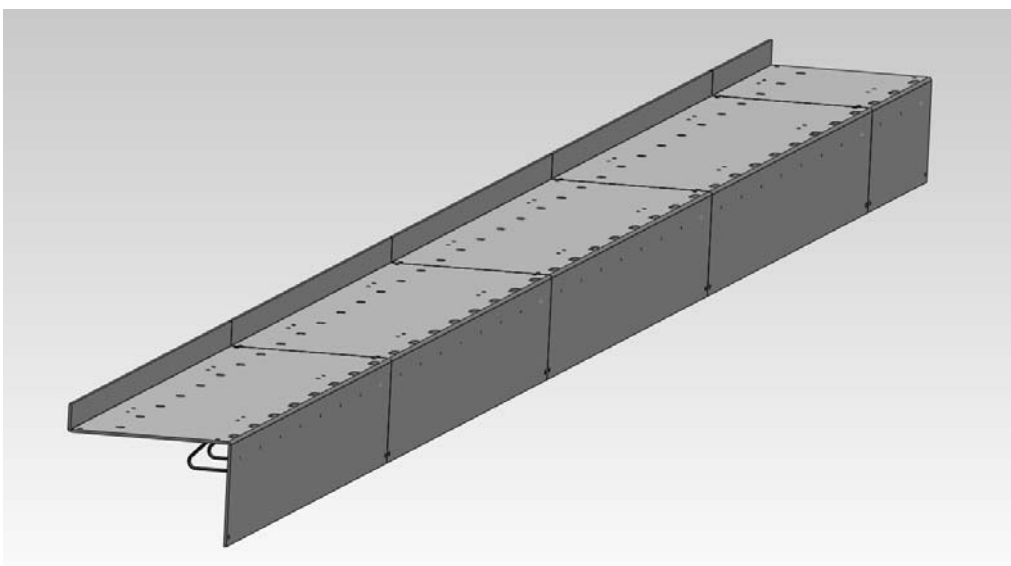

### 3. Positioning.

Hang the so obtained formworks to steel beams in order to put them at the design altitude. For the smaller joints (AGFJ 100 included), you'll have to hang the complete joint package (finger element + waterproof strip + angular steel plate).

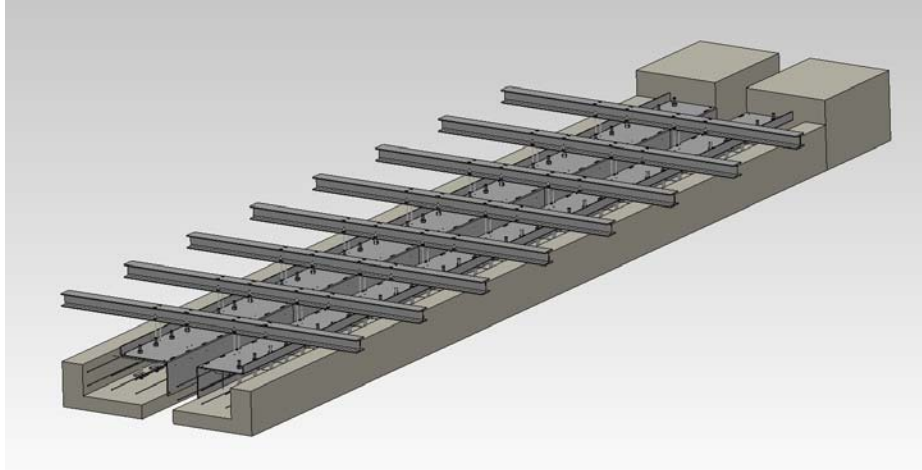

### 4. Casting.

Cast the concrete under the formwork; if necessary, use a primer to improve the adhesion on the existing concrete. Wait till concrete blocks have reached the correct hardening.

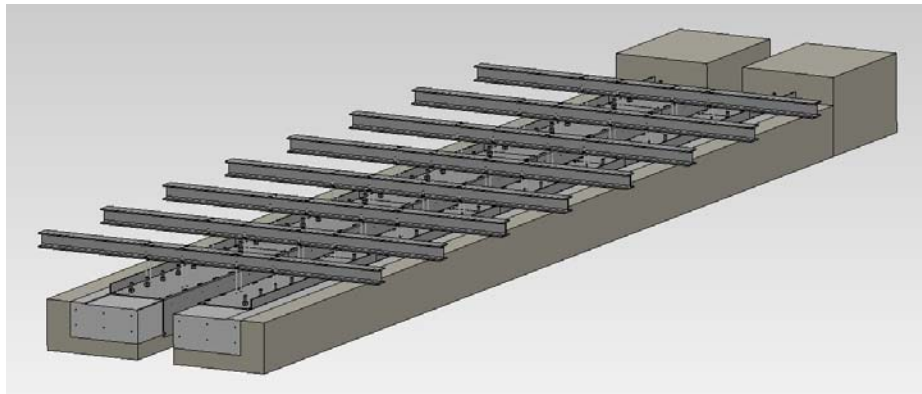

### 5. Installation of waterproof strip.

For the smaller joints (AGFJ 100 included), the waterproof strip is already in its position.

For the larger joints, fix the waterproof strip with the special screws to the formworks and then put the finger elements in their position.

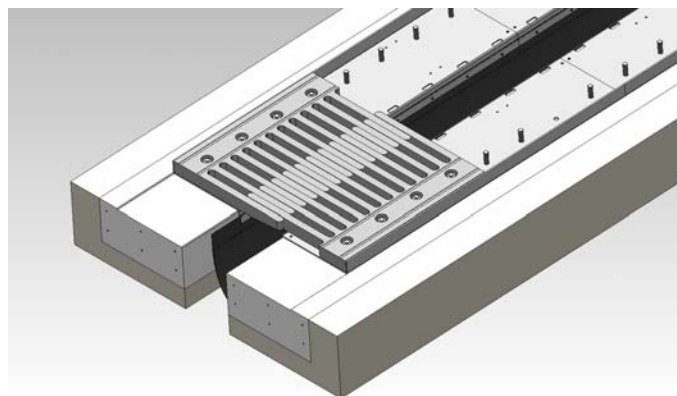



**6. Anchors fixing.**

When all the finger elements are in their position, fix them with washers, nuts and locknuts.

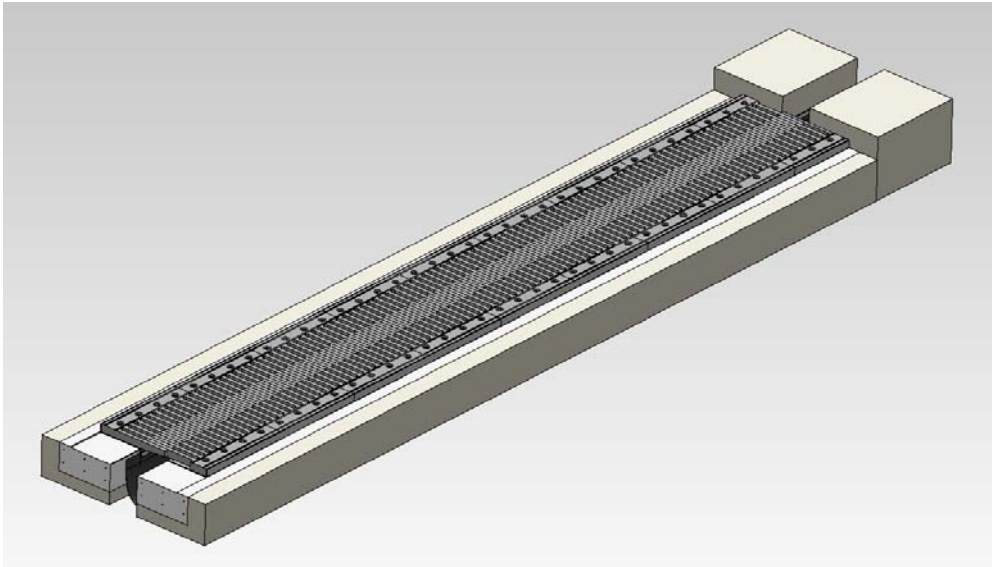

**7. Finishing.**

Put the asphalt up to the finger plates. Seal the possible space between asphalt and finger plates by using mastic asphalt.

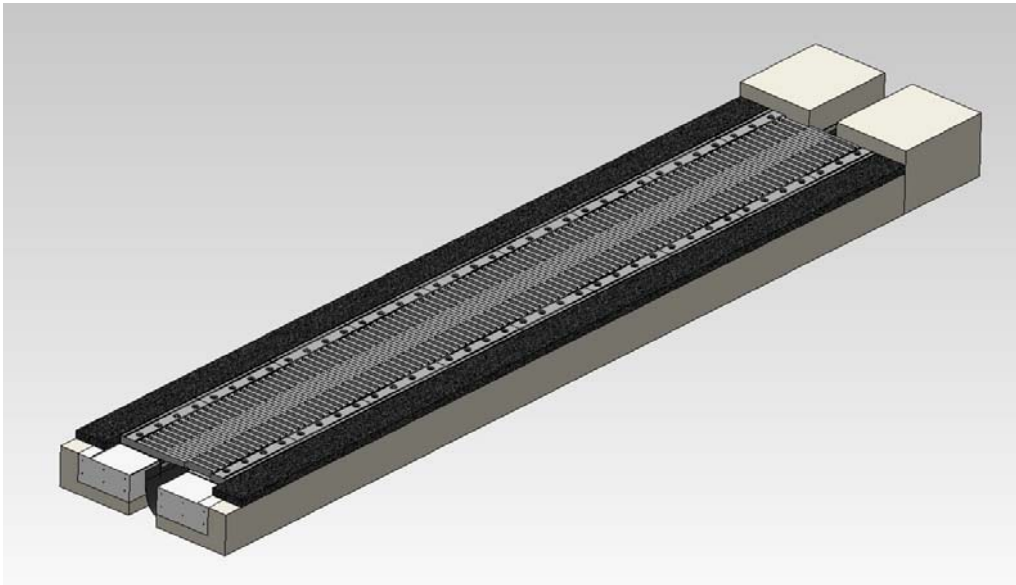

AGOM reserves the right to make changes to the project thus reported in this catalogue in order to improve the product.

**Materials**

Structural steel properties comply with EN 10025.

grade	resiliency min (20°C) [J]	elasticity modulus [MPa]	tensile strength [MPa]	yielding stress min $F_y$ [MPa]						
				<i>nominal thickness [mm]</i>						
				≤16	>16	>40	>63	>80	>100	>150
					≤40	≤63	≤80	≤100	≤150	≤200
S355JR	27	206000	450÷680	355	345	335	325	315	295	285
S275JR	27	206000	410÷580	275	265	255	245	235	225	215

Zinc coated threaded bars are used, whose properties comply with EN ISO 898.

class			6.8	8.8
tensile strength min	$f_t$	[MPa]	600	800
yielding stress min	$f_y$	[MPa]	480	640
elongation at break	A	[MPa]	≥8%	≥12%

### Maintenance and replacement

AGOM AGFJ expansion joints, if correctly installed, are theoretically free from maintenance. Normally the joint element does not require any surface regular cleaning, because its shape and the movement cycles will push dirt out. In any case if during inspection some objects (typically small stones, etc..) are inside the fingers they have to be removed for joint perfect functioning.

We suggest to perform the following inspections to guarantee the joint right functioning:

1. a first inspection just at the end of installation to verify the right positioning and height in respect to the final pavement;
2. an inspection after a year of service, in order to visually detect any eventual damage on the joint or on the adjacent zones; during inspection, the joint surface must be checked in order to verify there are no significant damages due to transit of unexpected vehicles (example excavator vehicle) or damages due to crashes (lost of fuel or surface burning). If joint elements damages occurred, AGOM technicians must be contacted and eventually the element shall be replaced.
3. a visual inspection per five years in order to detect damages due to traffic, in particular on the anchor bars of the joint. During this inspection the same items already described at point 2 of this procedure (inspection after one year) shall be repeated to ensure the expansion joint right functioning.

In any case if any particular problems are detected, the inspector shall call AGOM International to have a guidance to correctly operate.

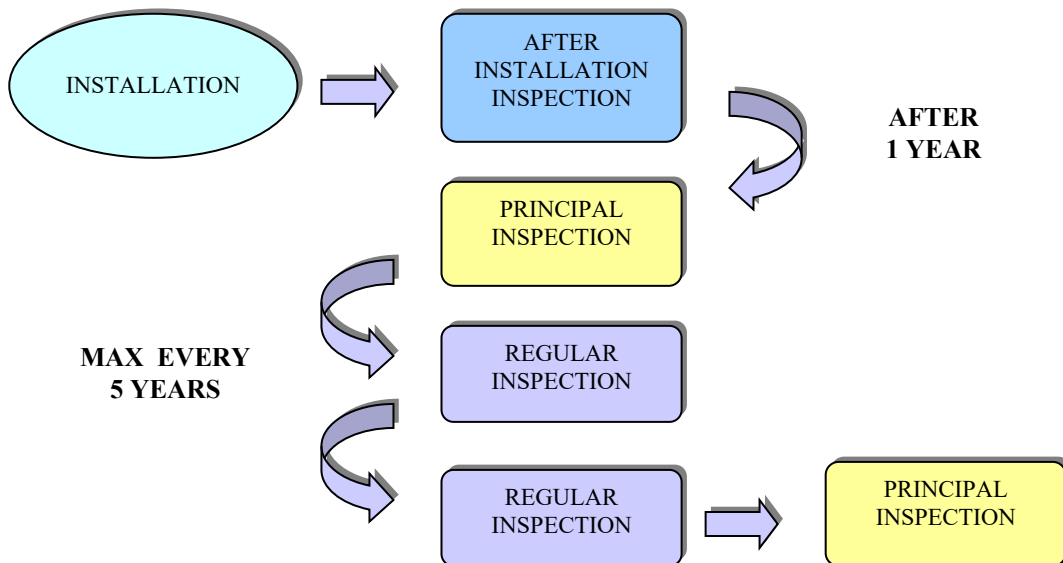

If replacement is necessary, installation phases shall be repeated, after demolishing the concrete parts included in the blockout and removing the existing joint.

**MORE THAN 50 YEARS EXPERIENCE DESIGNING AND MANUFACTURING DEVICES FOR CONSTRUCTION, OFFSHORE AND INDUSTRIAL MARKETS**



**Bridge bearings**

- Elastomeric Bridge bearings
- Pot bearings
- Spherical bearings
- Incremental Launching bearings
- Horizontal load bearings
- Special bearings

**Seismic Isolators**

- High damping rubber bearings
- Lead core rubber bearings
- Multilayer rubber bearings
- Shock transmitters
- Shock absorber
- Rubber dampers

**Expansion joints**

- Elastomeric joints
- Joints for high movements
- Finger joints
- Buried joints
- Railway joints

**Services**

- Design
- Consulting
- On site assistance
- Installations
- Tests
- Inspection

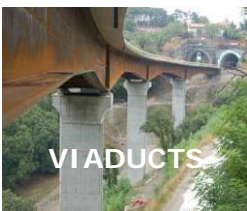
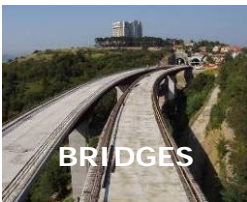

**AGOM INTERNATIONAL SRL** Via Mesero, 12 – 20010 Ossona (MI) - Italy PH.: +39 02 9029111 – FAX:+39 02 9010201 [www.agom.it](http://www.agom.it) - e-mail: [agom@agom.it](mailto:agom@agom.it)



UNI EN ISO 9001:2008



SISTEMA DI GESTIONE QUALITÀ CERTIFICATO



CERTIQUALITY È MEMBRO DELLA FEDERAZIONE CISQ



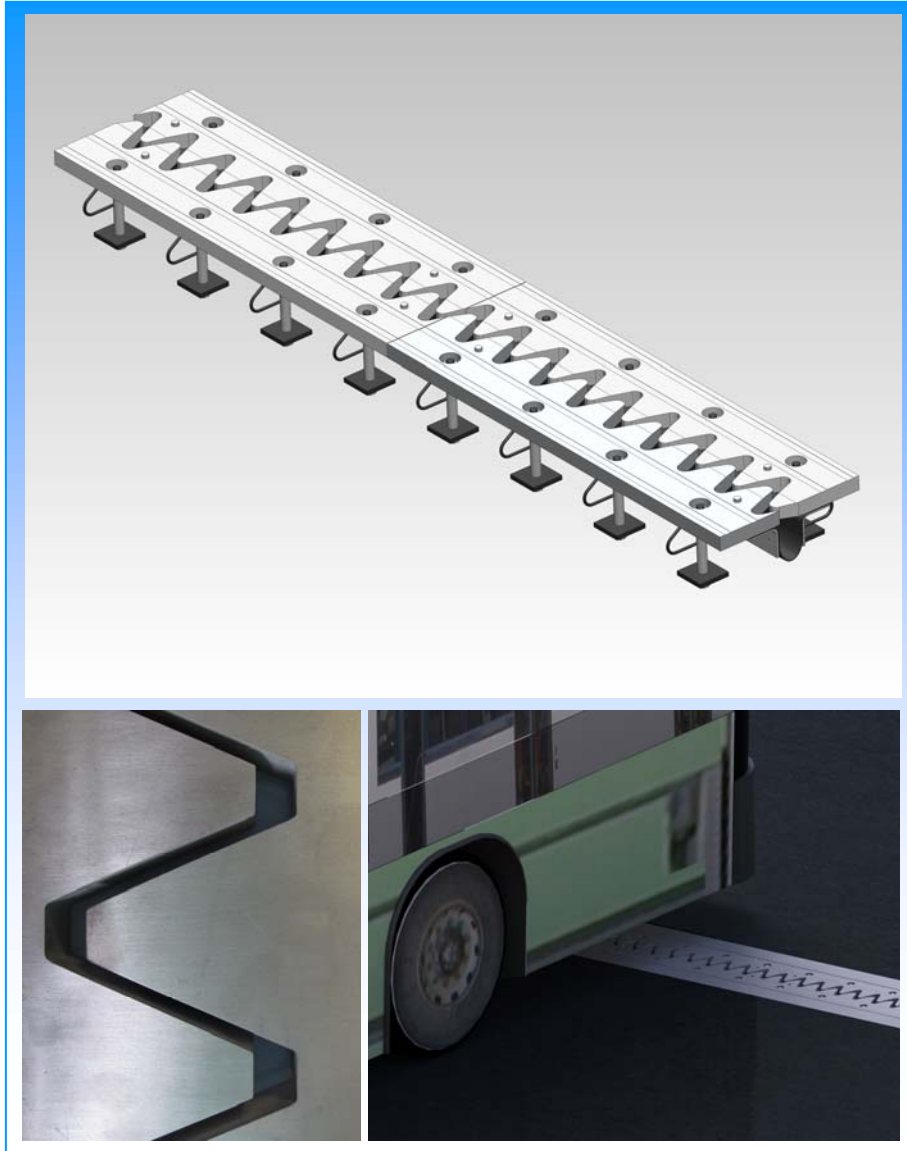

# CANTILEVER METALLIC JOINTS

## **AGOM INTERNATIONAL SRL**

Via Mesero, 12 - 20010 Ossona (MI) - Italy - [www.agom.it](http://www.agom.it)  
PH.: +39 02 9029111 - FAX: +39 02 9010201 - [agom@agom.it](mailto:agom@agom.it)



## *Building and engineering*

Bridges are subjected to movements and rotation caused by traffic, temperature changes, earthquakes, shrinkage, post-tensioning, creep, etc. Bridge construction requires carefully designed and manufactured bearings, anti-seismic devices, shock absorbers and expansion joints to ensure that such forces are properly dealt with throughout the life of the structure.

AGOM has over 50 years experience in design and manufacturing of bridge bearings, bridge expansion joints, anti-seismic devices and shock absorbers for the bridge-building and construction industry. All products comply with the latest European standards and all main international standards.



The quality and durability of these products are ensured by:

- our team of skilled engineers to conceptualise and design the most appropriate engineering solutions
- qualified professionals trained and continually updated in quality production techniques
- virgin raw materials that are quality assessed in our on-site testing laboratory
- ISO 9001:2008 quality standard accreditation
- strict quality control processes
- periodical external inspections by globally recognized bodies such as the Polytechnic University of Milan and Certiquality

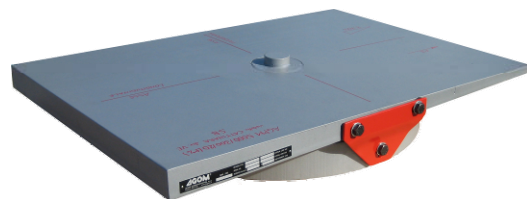

## *Bridge Deck Movements*

The horizontal movements of a bridge superstructure are due to :

- Temperature expansion and contraction
- Shrinkage of concrete
- Shortening of concrete due to creep effect
- Elastic shortening
- Movements due to induced external loads (e.g. earthquake, wind, vehicular braking etc.)



### Temperature

Temperature variations cause both expansion and shortening of the bridge deck and are usually computed as a plus and minus range about a mean structure temperature which occurs when the superstructure is placed on the bearings. Temperature differentials also occur in the deck from top to bottom and from one side to other side of the deck. Temperature differentials through the depth of the deck have little effect on the bearings and piers but those from one side of the deck to the other cause the deck to bend in plan which results in horizontal forces on the bearings and piers.

### Shrinkage of concrete

Shrinkage of concrete results in the shortening of the bridge superstructure. This effect depends upon factors such as quality of concrete used, size of the member, relative humidity and time after casting.

### Shortening due to creep effect

Effect of creep of concrete under post-tensioning and other permanent loads results in the shortening of the superstructure. It is a time dependent effect.

### Elastic shortening

This phenomenon occurs in case of pre-stressed superstructure during post-tensioning. The amount of shortening depends on the stage at which the superstructure is placed on the bearings and also at what stage it is post-tensioned. Sometimes, partial or complete tensioning may be carried out before the superstructure is placed on the bearings thus eliminating this shortening from affecting the bearings at least partly.

## AGFJ cantilever metallic joints

AGFJ expansion joint elements are specially designed and manufactured for traffic safety in accordance with ETAG n.32.

The gap between structures is overpassed by metallic cantilever, trapezoidal shape elements that intersect, thus reducing the voids to small spaces.

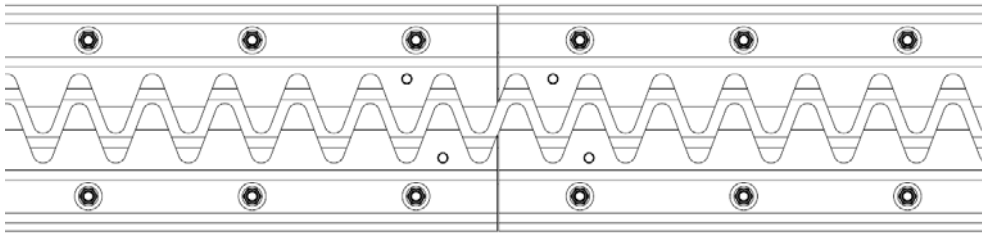

Metallic elements are fixed to reinforced concrete using suitable corrosion-resistant galvanized anchor bolts to absorb elastic reactions, mechanical vibrations and other movements of the structure. Folded galvanized steel plates are supplied together with the cantilever elements to allow an easier installation and to protect the edge of concrete subjected to concentrated loads.



A waterproof strip is put below the cantilever elements to collect water and bring it towards the draining pipes.

AGFJ series are intended for vehicles traffic.

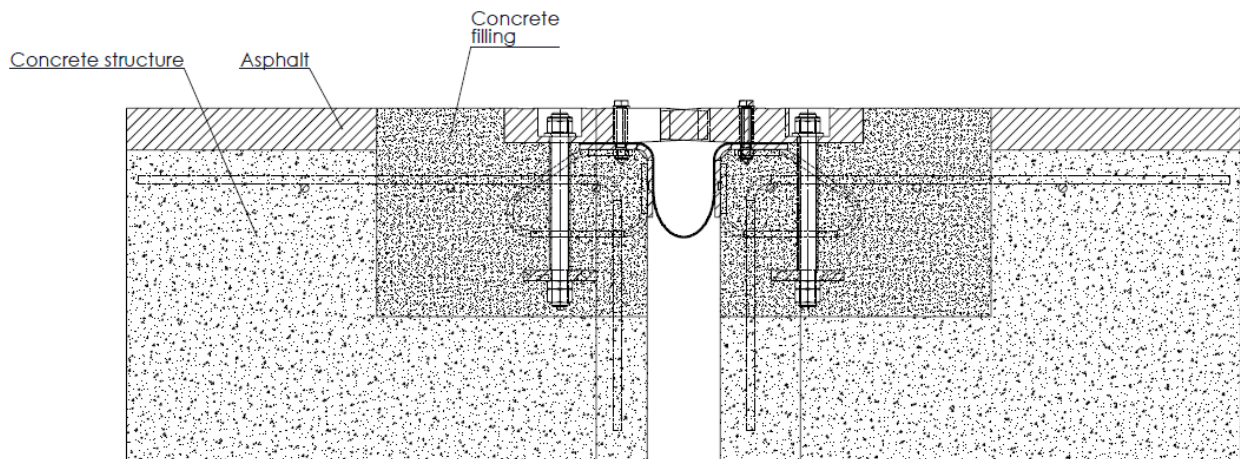

*Typical current section*

## Features

AGFJ expansion joints has the following main characteristics:

- movement capacity up to  $\pm 50$  mm;
- structural elements from galvanised steel S355JR EN10025 or aluminium alloy Peraluman 460;
- galvanised anchors with self-locking nuts;
- continuous watertight strip system;
- smooth transit over the expansion joints;
- footpath cover plates can be provided if required;
- vertical misalignment can be compensated during installation.

So their benefits can be summarized as below.

Feature	Benefit
Quality	Made of high resistance certificated materials.
Efficiency	Minimal maintenance requirements.
Skid Resistance	Each element is provided with surface grooves which allow for proper water drainage.
Low Noise	Special design reduces the noise while vehicles pass over it.
Long Service Life	Designed for heavy traffic.

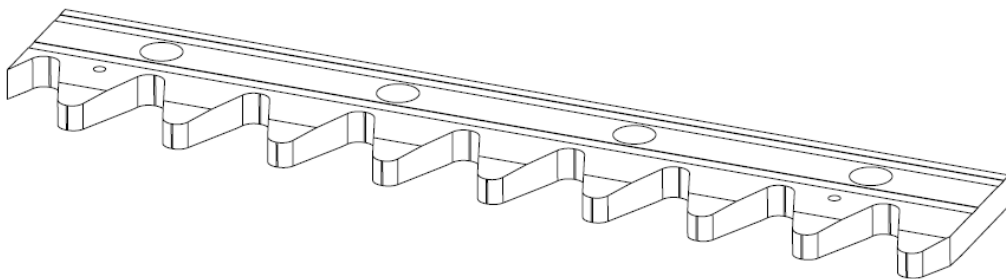

### *Dimensions*

AGFJ expansion joints are supplied in standard elements with length about 1 m and has the following dimensions:

<b>Model</b>	<b>Movement (mm)</b>	<b>Installation Gap (mm)</b>	<b>Width of top surface* (mm)</b>	<b>Anchor bars</b>	<b>Anchor bars spacing (mm)</b>
AGJF 80T	±40	60	344	M16x200	250
AGJF 100T	±50	70	378	M16x200	250

\*at installation, in average position



## Installation

The following installation procedure is very important and shall be fully read and understood prior to beginning any works. To ensure proper installation and performance of expansion joint system the following actions must be complied by skilled people. Errors during installation will affect product warranty.

- a) Read and understand installation procedure.
- b) Inspect all the materials supplied.
- c) Inspect the adjacent concrete structure for acceptance before beginning works.
- d) Study and verify the shop drawings.

### 1. Preparation of the joint zone.

Scarify the concrete deck near the joint edges, according to the dimensions suggested in AGOM drawings. Prepare the reinforcement bars in the zone where joint will be anchored.

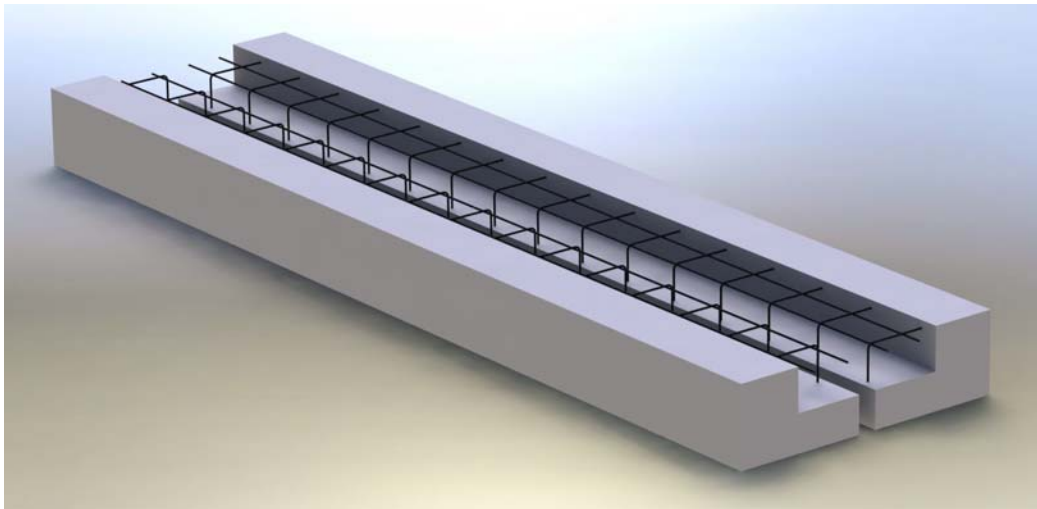

### 2. Positioning.

Hang the 1 meter elements (complete of anchors) to steel beams in order to put them at the design altitude and connect the angular steel plates each other. In this phase the waterproof strip is not put yet in its position.

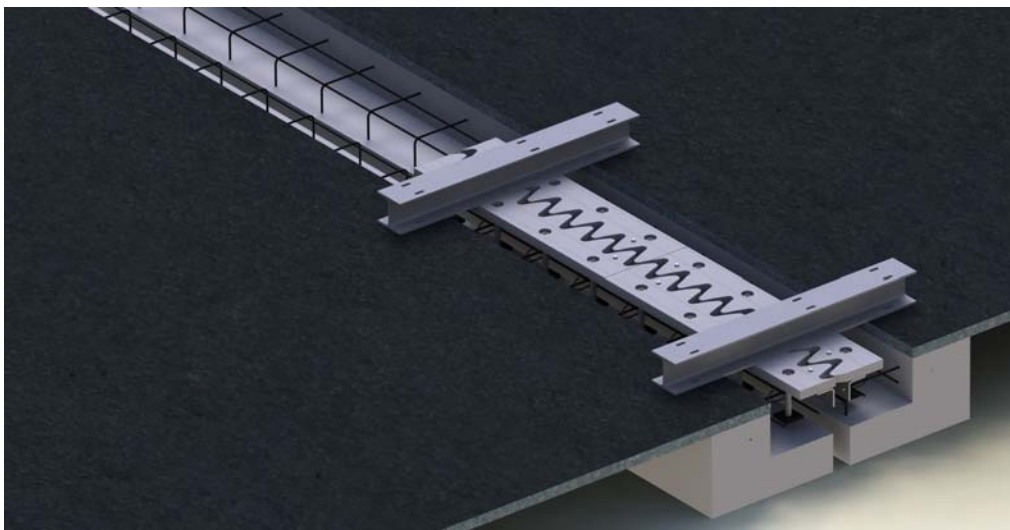

The beams shall be prepared as shown in the drawing 01764IP.  
It's important that the upper surface of the joint is positioned 2-3 mm under the upper surface of the asphalt.  
The lower and the lateral surfaces of the joint shall be coated with a release agent, to make easy separating the finger elements from concrete.

### 3. Casting.

Cast the concrete under the formwork; if necessary, use a primer to improve the adhesion on the existing concrete. Wait until concrete blocks have reached the correct hardening.

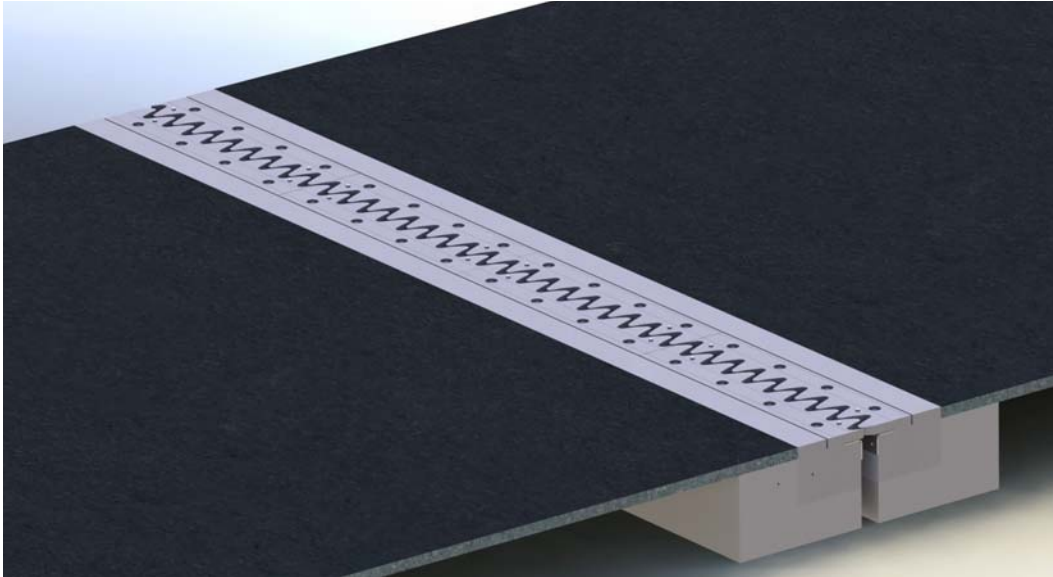

### 4. Installation of waterproof strip.

Remove the small screws that connect the joint elements to the below angular plates.  
Unscrew the nuts of the anchor bars and remove all the trapezoidal elements.

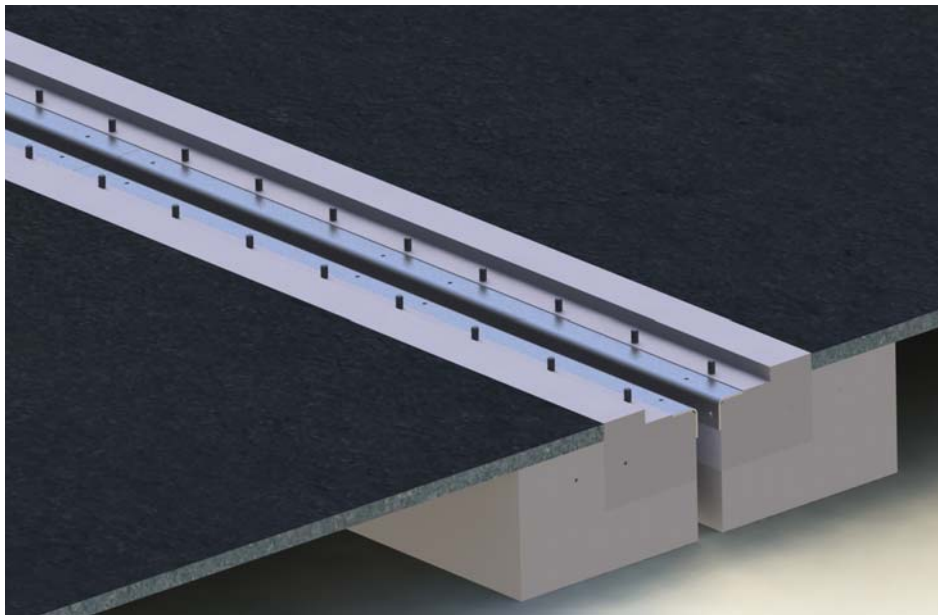

Put the waterproof strip in its position. You can start from one edge without rolling it out completely, but taking care about its correct alignment with the angular plate, then you can put the first finger elements and fix them with nuts. If necessary, you can use a bit of glue (for example Loctite) to take the strip in position.

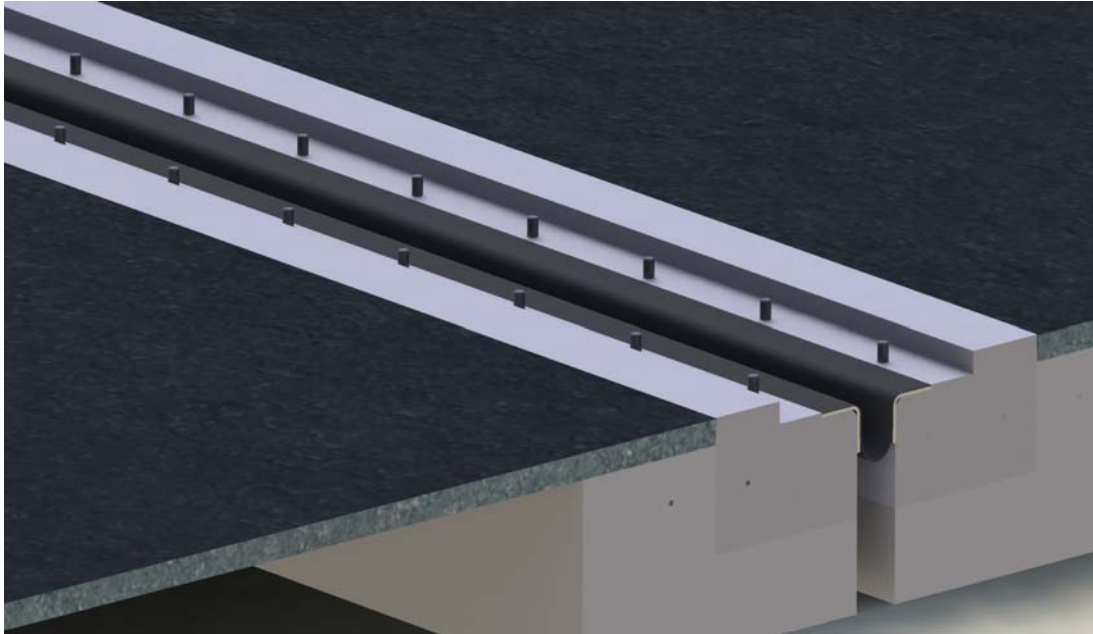

#### **5. Anchors fixing.**

Put again all the joint elements and, when they are all in their position, fix them with washers and locknuts.

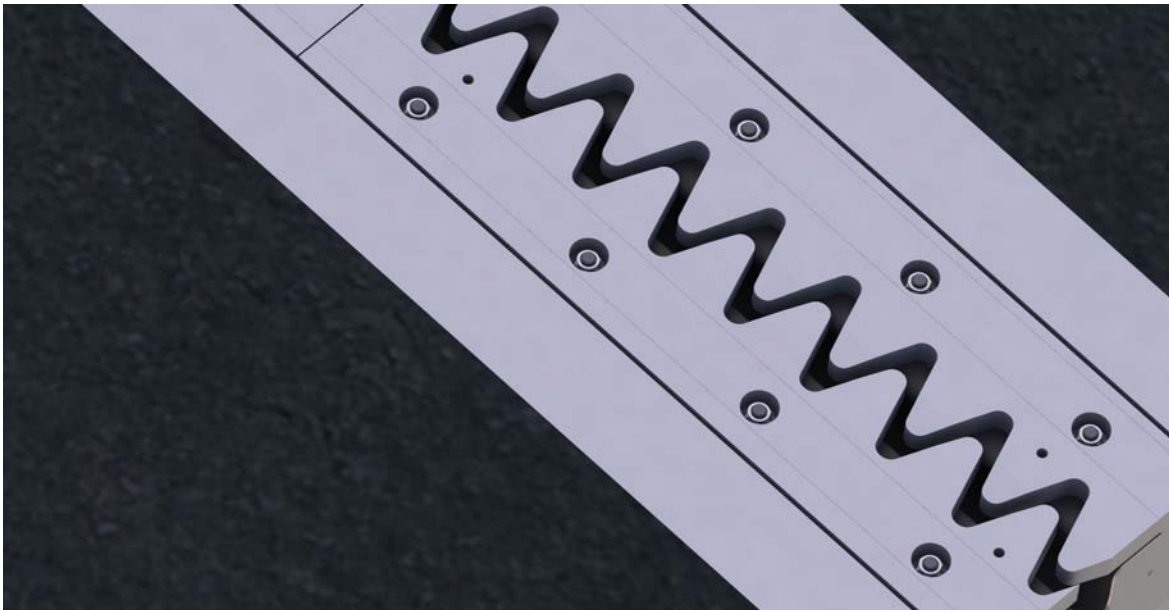

**6. Finishing.**

To reduce noising, you can seal the holes used for anchors with a suitable material (i.e.: Mapeflex PU65 by Mapei).

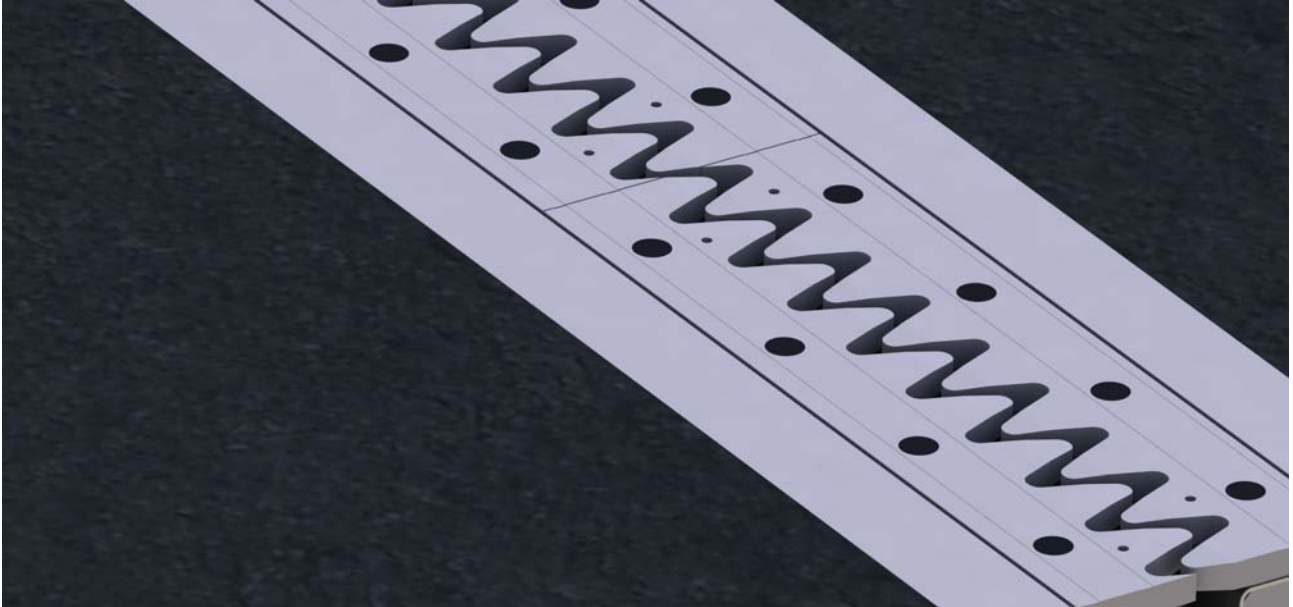

AGOM reserves the right to make changes to the project thus reported in this catalogue in order to improve the product.

**Materials**

Structural steel properties comply with EN 10025.

grade	resiliency min (20°C) [J]	elasticity modulus [MPa]	tensile strength [MPa]	yielding stress min $F_y$ [MPa]						
				<i>nominal thickness [mm]</i>						
				≤16	>16	>40	>63	>80	>100	>150
					≤40	≤63	≤80	≤100	≤150	≤200
S355JR	27	206000	450÷680	355	345	335	325	315	295	285
S275JR	27	206000	410÷580	275	265	255	245	235	225	215

Aluminium properties comply with EN 485-2.

alloy	elasticity modulus [MPa]	proof stress [MPa]	tensile strength [MPa]
5083	71000	>240	>295

Zinc coated threaded bars are used, whose properties comply with EN ISO 898.

class			6.8	8.8
tensile strength min	$f_t$	[MPa]	600	800
yielding stress min	$f_y$	[MPa]	480	640
elongation at break	A	[MPa]	≥8%	≥12%



**Maintenance and replacement**

AGOM AGFJ expansion joints, if correctly installed, are theoretically free from maintenance. Normally the joint element does not required any surface regular cleaning, because its shape and the movement cycles will push dirt out. In any case if during inspection some objects (typically small stones, etc..) are inside the fingers they have to be removed for joint perfect functioning.

We suggest to perform the following inspections to guarantee the joint right functioning:

1. a first inspection just at the end of installation to verify the right positioning and height in respect to the final pavement;
2. an inspection after a year of service, in order to visually detect any eventual damage on the joint or on the adjacent zones; during inspection, the joint surface must be checked in order to verify there are no significant damages due to transit of unexpected vehicles (example excavator vehicle) or damages due to crashes (lost of fuel or surface burning). If joint elements damages occurred, AGOM technicians must be contacted and eventually the element shall be replaced.
3. a visual inspection per five years in order to detect damages due to traffic, in particular on the anchor bars of the joint. During this inspection the same items already described at point 2 of this procedure (inspection after one year) shall be repeated to ensure the expansion joint right functioning.

In any case if any particular problems are detected, the inspector shall call AGOM International to have a guidance to correctly operate.

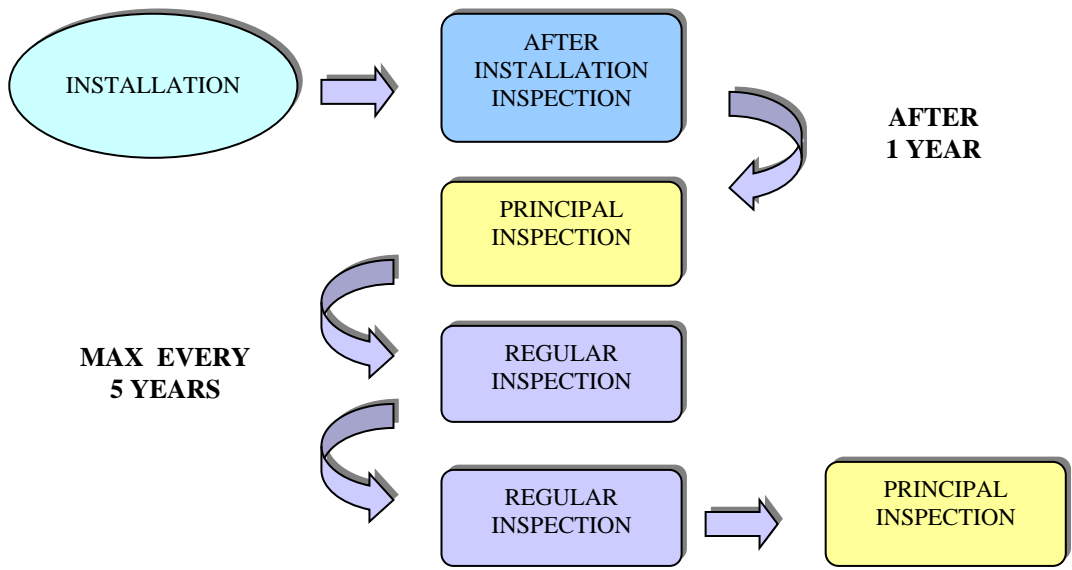

If replacement is necessary, installation phases shall be repeated, after demolishing the concrete parts included in the blockout and removing the existing joint.

**MORE THAN 50 YEARS EXPERIENCE DESIGNING AND MANUFACTURING DEVICES FOR CONSTRUCTION, OFFSHORE AND INDUSTRIAL MARKETS**



**Bridge bearings**

- Elastomeric Bridge bearings
- Pot bearings
- Spherical bearings
- Incremental Launching bearings
- Horizontal load bearings
- Special bearings

**Seismic Isolators**

- High damping rubber bearings
- Lead core rubber bearings
- Multilayer rubber bearings
- Shock transmitters
- Shock absorber
- Rubber dampers

**Expansion joints**

- Elastomeric joints
- Joints for high movements
- Finger joints
- Buried joints
- Railway joints

**Services**

- Design
- Consulting
- On site assistance
- Installations
- Tests
- Inspection

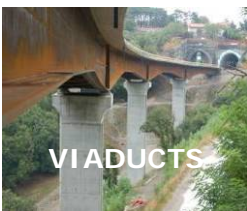

**AGOM INTERNATIONAL SRL** Via Mesero, 12 – 20010 Ossonova (MI) - Italy PH.: +39 02 9029111 – FAX:+39 02 9010201 [www.agom.it](http://www.agom.it) - e-mail: [agom@agom.it](mailto:agom@agom.it)



UNI EN ISO 9001:2008



SISTEMA DI GESTIONE QUALITÀ CERTIFICATO



CERTIQUALITY È MEMBRO DELLA FEDERAZIONE CISQ

