

AGOM INTERNATIONAL SRL con Socio Unico
Via Mesero, 12 – 20010 Ossona (MI) – Italy - www.agom.it
TEL: +39 02 9029111 – FAX: +39 02 9010201 – agom@agom.it

Elastomeric bearings AGOM E-Link

AGOM elastomeric bearings are built to withstand loads and simultaneous deformation in any direction, while also allowing for minor rotations in any of the bearing's axes. AGOM E-Link bearings can be made entirely of rubber or can be reinforced with special sheet steel to increase capacity and transversal strength.

Bearings can also be produced with special anchor plates or with sliding surfaces to improve the structure's displacement capacity. This kind of bearing can withstand vertical loads of up to **22000 kN**.

E-Link F plain pad bearings

AGOM **E-Link F** non-reinforced bearings can be used in many construction and civil engineering applications to support concrete and steel structures, and where a simple, low-cost rubber separation strip is capable of carrying compressive loads, while at the same time providing transactional movement and rotational capacity. Plain pad bearings have a large and varied range of possible applications though these bearings are more typically used in prefabricated structures.

On request the E-Link F plain pad bearings can also be provided with a non-fading mark directly moulded on the rubber.



E-Link B laminated bearings

AGOM's reinforced bearings **E-Link B** are designed for use in bridge and building structures as a vertical load bearing component capable of providing transactional movement in any direction and simultaneous rotational capacity.

AGOM E-Link B elastomeric bridge bearings with simple reinforcement are made up of multiple elastomeric layers separated by reinforcing steel plates moulded on the actual layers, and can be manufactured in a rectangular or circular shape to meet individual engineering requirements.

These products are simple, robust and corrosion free as the steel inserts are covered entirely in rubber. Easy to install, they will provide long problem-free service.



Elastomeric bearing with external anchor plates

One or two anchor plates can be directly vulcanised to the elastomeric bearings during manufacturing, in order to connect the bearing to the structure by means of mechanical anchorage, so avoiding problems of relatives movements.

AGOM can manufacture and supply different types depending on the anchorage system that is required by the Project.

E-Link Type C2

Elastomeric bearing with two external plates and holes for plain anchor bars, primarily for use on in situ cast concrete structures.



E-Link Type C2E

Elastomeric bearing with two external plates and holes, greater than the rubber shape. The horizontal loads are transferred from structures to bearing by means of steel bars or screws bolted to the external plates.



E-Link Type C3

Elastomeric bearing with two outer plates with threaded holes for use on metal structures, or as an anti-lift device; in the latter case, suitable anchor bars to withstand the design loads must be inserted into the support.



E-Link Type C4

Elastomeric bearing with external plates and pins that connect to suitable steel counterplates in order to secure the bearing to the structure and to allow an easy replacement.



E-Link Type C4E

Elastomeric bearing with external plates and an upper pin that connect to a suitable steel counterplate in order to secure the bearing to the structure and to allow an easy replacement.



E-Link Type C5

Elastomeric bearing with two suitably etched external plates to facilitate the bearing's bonding to the structure with glue.



E-Link Type BF

Elastomeric bearing with external plates and restraints that prevent any horizontal movement, in order to obtain a fixed point.



E-Link Type BG

Elastomeric bearing with external plates and restraints that prevent horizontal movements in one direction while allowing (limited) movements in the perpendicular direction, in order to obtain a guided bearing.



Elastomeric bearings with PTFE surface

When a large horizontal displacement capability is required, it's possible to use elastomeric bearings with a PTFE / stainless steel sliding surface.

The options are as follows:

E-Link Type D

Elastomeric bearing with a vulcanized PTFE sheet to reduce the coefficient of friction with the welded stainless steel on the upper movable plate: it's a support designed to allow free movement in the longitudinal and transverse directions. According to EN1337-3, this type can only be used as temporary support.

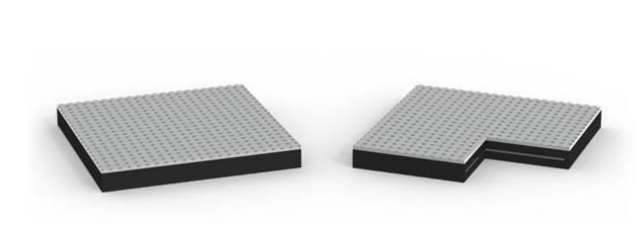

E-Link Type E

Elastomeric bearing with a PTFE sheet embedded in the vulcanised top plate, to reduce the coefficient of friction with the welded stainless steel on the upper movable plate: it's a support designed to allow free movement in the longitudinal and transverse directions.

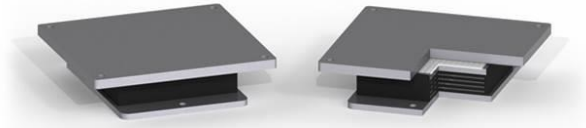

E-Link Type EG

Elastomeric bearing with a guided sliding plate: it allows movements in the longitudinal direction, while preventing them in the transverse direction by means of steel guides. A sheet of PTFE is embedded in the vulcanized top plate, to reduce the coefficient of friction with the stainless steel, welded to the upper movable plate.



Quality and International Standards

AGOM E-Link elastomer bearings are designed and manufactured in accordance with the requirements of the European standard **EN 1337-3** and are qualified with the **CE mark**. AGOM can also provide elastomeric bearings in accordance with other standards of a wide range of international standards (British **BS 5400**, American **AASHTO**, Canadian **CSA**,...). The compound used in the molding process can be polychloroprene (neoprene), natural rubber or SBR depending on the required specifications. Every single steel component is mechanically worked and assembled by fully qualified and trained workers inside the AGOM factory under strict **ISO 9001:2015** accredited quality control standards.



Materials

Rubber compound

The elastomer used in the machining process can be polychloroprene or neoprene (CR), natural rubber (NR) or SBR according to the required specifications. The mechanical properties of the elastomer are shown in the tables below.

AGOM has an in-house research and development laboratory suitable for performing all the required quality controls of the compounds used in the production process. The AGOM quality control department controls each batch and certifies compliance with the standards, as provided by the required international regulations.



NATURAL RUBBER COMPOUND (NR)							
PROPERTY	UNITS	CNR 10018	BS 5400	EN1337 - 3	AASHTO M251	SETRA (Routes)	ISO 6446
HARDNESS	ShA3	60 ± 5	60 ± 5	60 ± 5	60 ± 5	60 ± 5	60 ± 5
		UNI 4916	BS 903 N-A26	ISO 48	ASTM D 2240	NFT 46 002	ISO 48
TENSILE STRENGTH	MPa	≥ 15,5	≥ 15,5	≥ 16	≥ 15,5	≥ 14	≥ 15,5
		UNI 6065	BS 903 A2	ISO 37 Type 2	ASTM D 412	NFT 46 002	ISO 37 Type 2
ELONGATION AT BREAK	%	≥ 350	≥ 400	≥ 425	≥ 450	≥ 450	≥ 400
		UNI 6065	BS 903 A2	ISO 37 Type 2	ASTM D 412	NFT 46 002	ISO 37 Type 2
TEAR RESISTANCE	kN/m	(a)	(a)	≥ 8	(a)	(a)	≥ 6
		/	/	ISO 34-1 Trouser	/	/	ISO 34-1 Trouser
COMPRESSION SET	%	≤ 20	≤ 30	≤ 30	≤ 25	≤ 20	≤ 30
		UNI 4913 (25% 70°C 24h)	BS 903 A-A6 (25% 70°C 24h)	ISO 815 (25% 70°C 24h)	ASTM D 395 B (25% 70°C 22h)	NFT 46 011 (25% 70°C 24h)	ISO 815 (25% 70°C 22h)
BOND TEST	N/mm	≥ 10	≥ 7	(a)	≥ 7	(a)	≥ 7
		UNI 5405	BS 903 B-A21	/	ASTM D 429 B	/	ISO 813
AGEING IN AIR TEST CODE	/	ISO 188	BS 903 A/B-A19	ISO 188	ASTM D 573	NFT 46 004	ISO 188
AGEING TEMPERATURE	°C	70	70	70	70	(b)	70
AGEING DURATION	h	96	168	168	70	(b)	168
HARDNESS Max Variation	ShA3	± 10	± 10	- 5 / + 10	± 10	± 15	± 10
TENSILE STRENGTH Max Variation	%	- 15	- 15	- 15	-25	- 15	- 15
ELONGATION AT BREAK Max Variation	%	- 20	- 20	-25	- 25	- 40	- 20
G MODULUS	MPa	0,9 ± 15%	(a)	0,9 ± 0,15	(a)	0,9 ± 15%	1,0 ± 15%
		CNR 10018	/	EN 1337-3 Ann. F	/	SETRA 4.4.2.3	ISO 1827
OZONE TEST CODE	/	UNI 6067 / 6068	BS 903 A43	ISO 1431 - 1	ASTM D 1149	(b)	ISO 1431 - 1
OZON TEST - O ₃	pphm	50	25	25	25	(b)	50
OZON TEST - ELONGATION	%	20	20	30	20	(b)	20
OZON TEST - TEMPERATURE	°C	40	30	40	38	(b)	40
OZON TEST - DURATION	h	96	96	96	48	(b)	96
OZONE TEST RESULT	visual examination	no cracks	no cracks	no cracks	no cracks	no cracks	no cracks
BRITTLENESS TEMP	°C	≤ - 25	≤ - 25	≤ - 25	≤ - 40	≤ - 25	≤ - 40
		UNI 7320	BS 903 A25	ISO 812	ASTM D 2137	ISO 812	ISO 812

(a) = not specified (b) = agreed upon request

POLYCLOROPRENE COMPOUND (CR)									
PROPERTY	UNITS	CNR 10018	BS 5400	EN1337 - 3	ISO 6446	AASHTO M251	SETRA (Routes)	DIN 4141	NBN T 32-001
HARDNESS	ShA3	60 ± 5	60 ± 5	60 ± 5	60 ± 5	60 ± 5	60 ± 5	60 ± 5	60 ± 5
		UNI 4916	BS 903 N-A26	ISO 48	ISO 48	ASTM D 2240	NFT 46 002	DIN 53 505	NBN T 31-002
TENSILE STRENGTH	MPa	≥ 15,5	≥ 15,5	≥ 16	≥ 13	≥ 15,5	≥ 14	≥ 19	≥ 13
		UNI 6065	BS 903 A2	ISO 37 Type 2	ISO 37 Type 2	ASTM D 412	NFT 46 002	DIN 53 504	NBN T 31-006
ELONGATION AT BREAK	%	≥ 350	≥ 350	≥ 425	≥ 400	≥ 350	≥ 450	≥ 450	≥ 400
		UNI 6065	BS 903 A2	ISO 37 Type 2	ISO 37 Type 2	ASTM D 412	NFT 46 002	DIN 53 504	NBN T 31-006
TEAR RESISTANCE	kN/m	(a)	(a)	≥ 10	≥ 6	(a)	(a)	≥ 10	(a)
		/	/	ISO 34-1 Trouser	ISO 34-1 Trouser	/	/	DIN 53 507	/
COMPRESSION SET	%	≤ 20	≤ 35	≤ 15	≤ 20	≤ 35	≤ 20	≤ 15	≤ 25
		UNI 4913 (25% 70°C 24h)	BS 903 A-A6 (25% 100°C 22h)	ISO 815 (25% 70°C 24h)	ISO 815 (25% 70°C 22h)	ASTM D 395 B (25% 100°C 22h)	NFT 46 011 (25% 70°C 24h)	DIN 53 517 (25% 70°C 24h)	NBN T 31-003 (25% 70°C 24h)
BOND TEST	N/mm	≥ 10	≥ 7	(a)	≥ 7	≥ 7	(a)	(a)	≥ 7
		UNI 5405	BS 903 B-A21	/	ISO 813	ASTM D 429 B	/	/	NBN T 31-008
AGEING IN AIR TEST CODE	/	ISO 188	BS 903 A/B-A19	ISO 188	ISO 188	ASTM D 573	NFT 46 004	DIN 53 508	NBN T 31-005
AGEING TEMPERATURE	°C	70	100	100	100	70	100	70	100
AGEING DURATION	h	96	72	72	70	70	72	168	72
HARDNESS Max Variation	ShA3	± 10	± 15	± 5	+ 15 - 3	± 15	± 15	± 5	± 7
TENSILE STRENGTH Max Variation	%	- 15	- 15	- 15	- 15	- 15	- 15	- 15	-20
ELONGATION AT BREAK Max Variation	%	- 20	- 40	-25	- 40	- 40	- 40	- 25	- 30
G MODULUS	MPa	O,9 ± 15%	(a)	O,9 ± 0,15	1,0 ± 15%	(a)	O,9 ± 15%	1,0 ± 0,2	≥ 0,8
		CNR 10018	/	EN 1337-3 Ann. F	ISO 1827	/	SETRA 4.4.2.3	DIN 4141	NBN T 31-001
OZONE TEST CODE	/	UNI 6067 / 6068	BS 903 A43	ISO 1431 - 1	ISO 1431 - 1	ASTM D 1149	(b)	DIN 53 509	NBN T 31-009
OZON TEST - O ₃	pphm	50	25	100	50	100	(b)	200	50
OZON TEST - ELONGATION	%	20	20	30	20	20	(b)	30	20
OZON TEST - TEMPERATURE	°C	40	30	40	40	38	(b)	40	40
OZON TEST - DURATION	h	96	96	96	96	100	(b)	96	100
OZON TEST RESULT	visual examination	no cracks	no cracks	no cracks	no cracks	no cracks	no cracks	no cracks	no cracks
BRITTLENESS TEMP	°C	≤ - 25	≤ - 25	≤ - 25	≤ - 40	≤ - 40	≤ - 25	≤ - 25	(a)
		UNI 7320	BS 903 A25	ISO 812	ISO 812	ASTM D 2137	ISO 812	ISO 812	/

(a) = not specified (b) = agreed upon request

Steel for reinforcement plates

Reinforcement plates and outer plates are made with steel according to the standard **EN 10025**.

Austenitic steel sheet

The austenitic steel used for sliding surfaces is X5CrNiMo17-12-2 in accordance with **EN 10088-2 1.4401** with a minimum thickness of 1.5 mm.

The roughness is $Ry5i \leq 1 \mu\text{m}$.

The hardness is $\geq 150 \text{ HV1}$ and $\leq 220 \text{ HV}$.

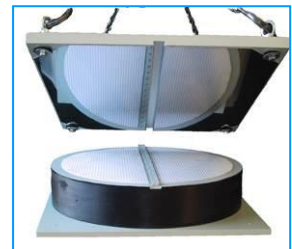

PTFE

AGOM uses only virgin PTFE without regenerated or filler materials.

The minimum thickness for bonded PTFE is 1.5 mm.

The minimum thickness of recessed PTFE is 4.5 mm and varies according with the bearings size and standard.



Characteristics	Test method	Requirements
Tensile strength (MPa)	ISO 527-1/3	≥ 29
Elongation at break (%)	ISO 527-1/3	≥ 300
Hardness	EN ISO 2039-1	H132/60=23 to 33 MPa

Bearing fixing

Generally, E-Link bearings with external steel anchor plates are provided with anchor bars suitable for attachment to the lower and upper parts of the structure.

In the case of prefabricated structures, bearings can be provided with an upper pin and a counterplate to be embedded in the concrete; in the case of steel beams, bearings can be supplied with an upper pin and / or fixing screws.

To account for the angle of inclination of the superstructure, the top plate of the elastomeric support can be made according to the drawing, taking into account the equivalent angle of inclination.



In case of simultaneous horizontal loads <20% of the vertical load and if there is sufficient friction between the support and the structure, it's possible to avoid the use of a mechanical anchorage with structure, and use cement or epoxy resins (if local regulations allow).

E-Link bearings accessories

Movement gauge

The movement indicator allows monitoring the sliding bearing displacements by using a reference arrow fixed to the bearing base and a graduate indicator moving with the sliding plate. The movement gauge allows to check the initial presetting of the bearing (if required) and to verify the bearing movement during the future inspections.



Dust protection

The (removable) dust protection around the sliding plate ensures the cleaning of the sliding surfaces to minimize the friction during sliding movements and guarantees the durability of the PTFE sliding material.



Corrosion protection

Steel components exposed to the elements are protected against corrosion. AGOM adapts the corrosion protection in accordance to the aggressiveness of the environment in which the bearings are to be installed and to each customer's requirements.

The standard corrosion protection according **EN 1337-9** is as follows:

- sandblasting grade SA2.5.
- two components high thickness epoxy zinc paint (min 250 µm).

The high resistant corrosion protection (metallization) is as follow:

- sandblasting de grade SA2.5
- metal spraying to 85 µm with Zn/Al 85/15
- sealing: epoxy sealer 20-25 µm
- top coat: polyurethane paint (min 100 µm)



Comprehensive Labelling

All the bearings with outer steel plates are provided with a metal label detailing the proprieties of the bearings:

- bearing type
- maximum vertical and horizontal loads
- rotation
- order number
- date of manufacture
- CE Mark



The top face of the bearing gives information on the type of the bearing, the direction of the axis of the bridge, the presetting (if any), the position.

Furthermore all E-Link bearings are provided with a non-fading mark directly molded on the rubber outlining the properties of the bearing:

- international standards
- order number
- date of manufacture
- CE Mark

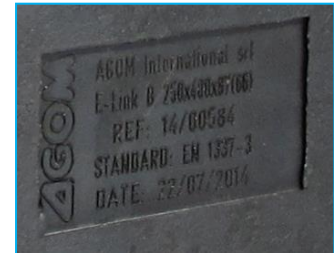

Guidelines for the design of a structure with AGOM E-Link bearings

In this section a simple guideline for the design of a structure equipped with AGOM bearing is presented.

The design procedure is summarized in the following steps:

1. Selection of the structure static link scheme (all simple elastomeric bearings or fixed and movable elastomeric bearings).
2. Calculation of the loads (vertical and horizontal) on the bearings according to the fixing scheme.
3. Calculation of the bearing rotations and movements.
4. Insertion of all the bearing design data into the bearing design table (example table B.1 of the EN1337-1 code attached at the end of the document).
5. Using the bearing drawings provided by AGOM, design of the interface parts between structure and bearings as: bearing lower plinth with adequate position for installing the bearing anchor bars (if required), level of the plinth to fit the vertical space between lower and upper structure to place the bearing and the upper structure interface where the bearing upper plate (if present) will be positioned.
6. If necessary, design of the slope compensator to be placed between the bearing and upper structure in order to adjust the permanent slope (longitudinal and transverse slopes of a bridge deck). The deck's slope must be always compensated in order to keep the sliding surface in the horizontal plane (normally the slope is compensated above the bearing between its sliding plate and the upper structure). In any case the whole bearing cannot be installed inclined.

Design of a structure with E-Link bearings

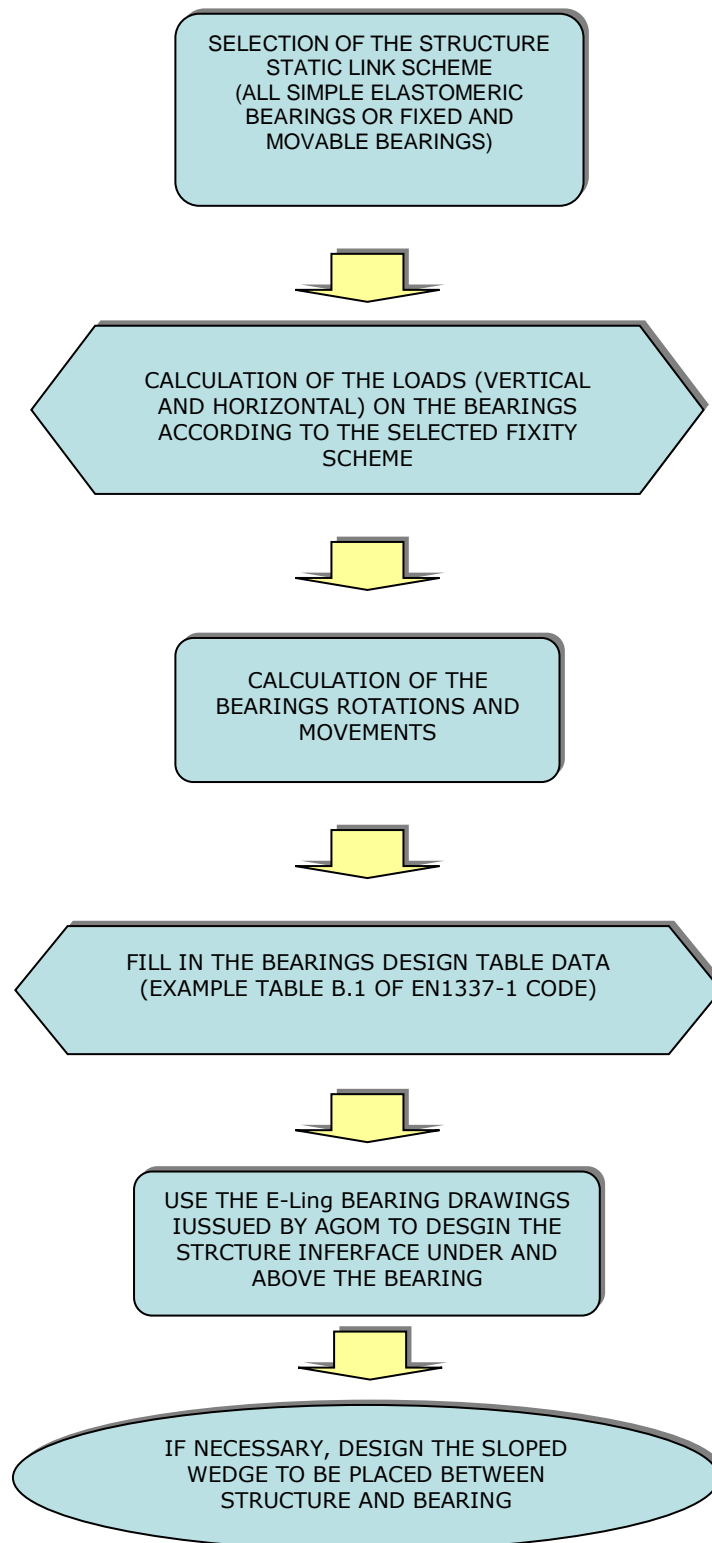

Comparison of bearing types performances

	V-MAX pot bearing	R-MAX spherical bearing	E-LINK rubber bearings
Vertical load	High	High	Medium
Horizontal displacement	No Limits	No Limits	Medium
Rotation	Medium	High	Low-Medium
Dimension	Small-Medium	Small-Medium	High

Advantages of using AGOM E-Link elastomeric bearings

AGOM E-Link bearings fulfil the following requirements:

- a. Transmit the vertical loads due to permanent and accidental effects; it is possible to cover a **wide range of loads about up to 22000 kN**
- b. Transmit the **horizontal loads** with or without **elastic response**
- c. Allow **rotation** as per a spherical hinge
- d. Capacity of **horizontal displacement**
- e. Suitable for all structures steel and concrete bridges and buildings
- f. **High durability and no maintenance**

**N_{ed, max}
UP TO
22000 kN**

**TRANSMIT
HORIZONTAL
LOADS**

**HORIZONTAL
DISPLACEMENT**

**HIGH
DURABILITY
NO
MAINTAINANCE**

Qualification, approval tests and certifications

All the qualification and approval tests are performed by independent and worldwide recognized laboratories to assure that the E-Link bearings' performances comply with the project and with international standard requirements.

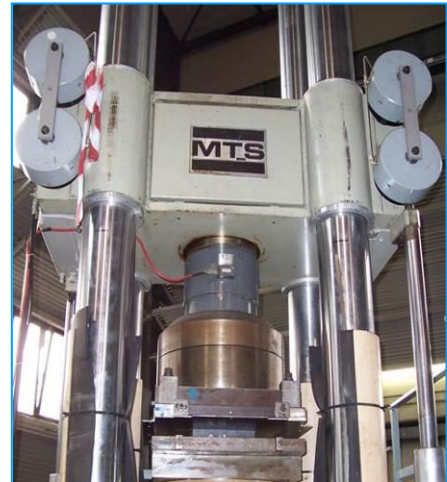
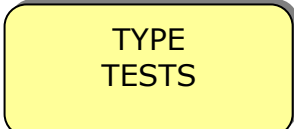
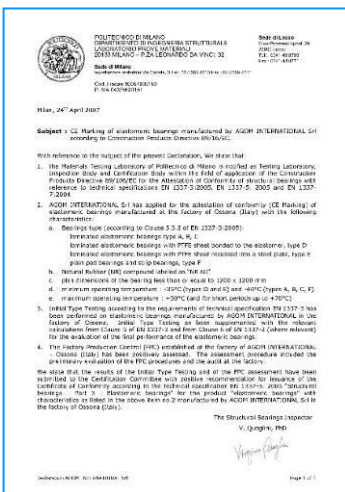
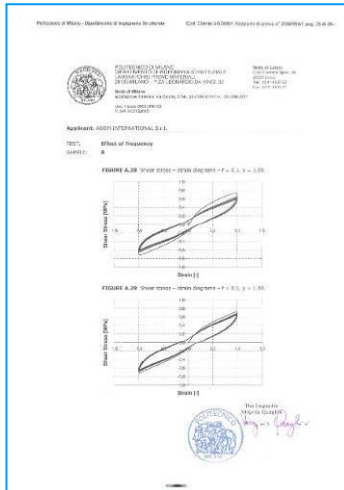
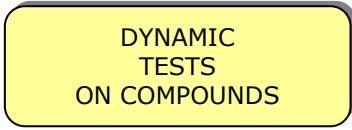
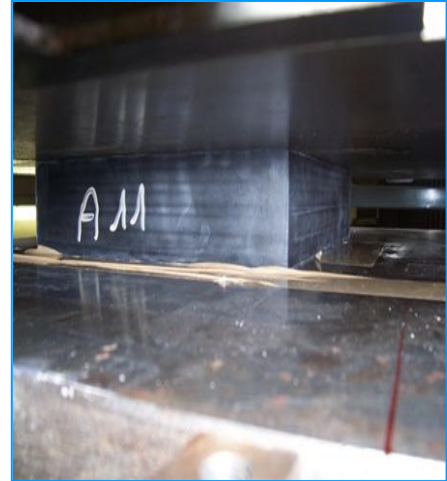
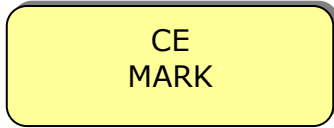

Installation and maintenance

This manual gives the main list of the most important operations to correctly install the AGOM bridge bearings.

Under control of the Engineer who designed the bridge, bearings must be installed by expert workers, with precision to meet the bridge and bearing design criteria.

Inappropriate handling, storage and installation will have an adverse effect on the bearing life, usually estimated in more than 50 years providing right maintenance.



AGOM structural bearings are manufactured to close tolerances by skilled technicians working in clean conditions.

To obtain the requisite performance from bearings it is imperative that they are properly handled at the work site and installed with the same care as when they were assembled in the factory.

AGOM bearings are clearly identified and marked on the top plate to ensure correct installation. The typeface on the cover or sliding plate gives information on the type, size and number of the bearing.

Moreover, arrows indicate the movement axis and the presetting direction (if applicable).

Every bearing is provided with a steel identification label with all the most important bearing information.

Handling and storage

Care should be taken in storage to prevent contamination and damage to the working surfaces. AGOM bearings should be stored in a controlled environment where they are protected from contamination, misuse and excessive moisture.

Robust transportation devices are fitted to all bearings to ensure that the components are maintained in their correct relative positions before and during installation.

The devices are normally finished in red paint.



Unless special devices have been specified, they should not be used for slinging or suspending the bearings beneath beams.

Due to unpredictable conditions, which may occur during transportation or handling on site, the alignment and presetting (if applicable) of the assembled bearing should be checked against the drawing.

Do not try to rectify any discrepancies on site.

Bearing too heavy to be lifted by hand should be properly slung using lifting equipment.

Presetting

If bearing are required to preset e.g. where once only large movements may occur during stressing operations, this should be specified as a requirement and should only be carried out in AGOM prior to despatch.

Do not attempt this operation on site.



Installation procedure

The installation procedure of the bearings generally depends on the structure type. Here the main steps for bearing with anchor bars are shown. If there are no anchor bars the procedure is similar without any requirements for the voids to place the bars.

1. Check before installation.

In order to avoid placements mistakes of the bearings, all the technical and description data, printed on the label, shall be checked and compared with the ones showed in the shop drawings.

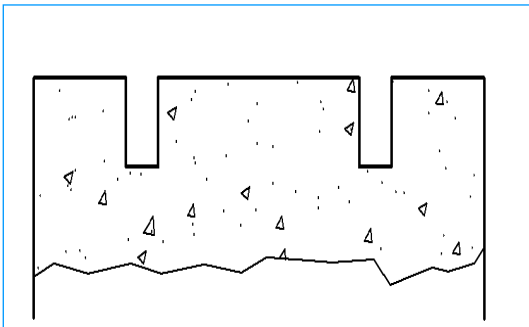

2. Casting of the substructures.

Substructures shall reach a level about 30 mm lower than the final level.

In order to install the bearings suitable voids spaces must be provided to insert the bearing lower anchor bars.

An easy way to leave the voids is to use corrugated steel pipes grouted into the concrete with a diameter at least double compared with the diameter of the anchor bars.

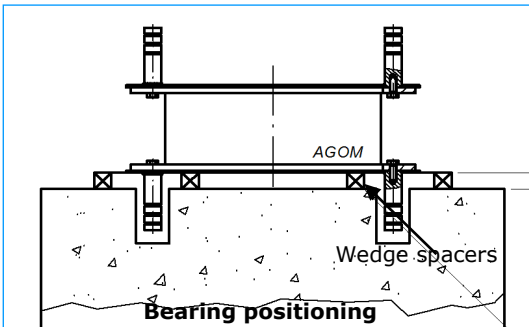

3. Bearing positioning and substructure casting.

The bearings are placed at the final exact level supporting it by temporary wedge spacers; the maximum deviation from the horizontal plan does not exceed 0.001 radians.

In order to fix the bearings and anchor bars a formwork around the lower base plate must be provided (normally a wood or steel formwork is used).

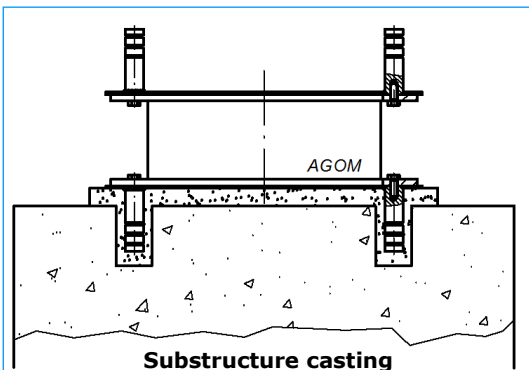

To grout the bearing a high strength non-shrink, quick setting cement mortar with compression strength > 45 MPa has to be used; if the thickness of the mortar exceeds 40 mm a suitable reinforcement shall be provided.

The temporary wedges used to keep the bearing in right position shall be removed after mortar hardening and remaining voids shall be filled by the same mortar.

The level of the cement mortar shall not exceed bottom level of the bearings steel lower plate to avoid bearings embedding compromising the eventual future bearing replacement.

4. Casting of the superstructure – cast-in-situ superstructure

Superstructure formwork must be arranged around the bearing upper steel plate and sealed with adhesive tape or foam to avoid concrete leakage during casting.

The formwork must be arranged in a suitable way to avoid embedding of the bearing upper plate into concrete to avoid bearing embedding compromising the eventual future replacement. The formwork must be supported at the design level during concrete pouring.

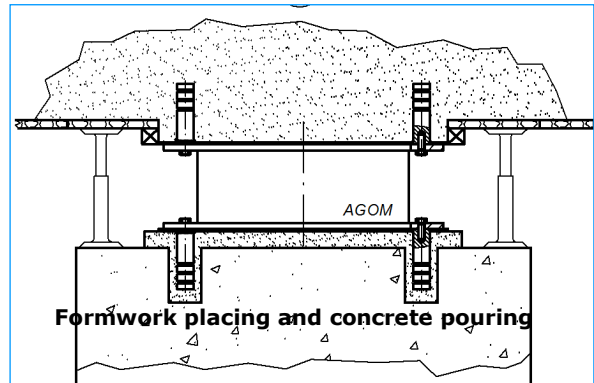

When the concrete has reached adequate resistance the supports and formwork have to be removed. At the end of the construction the bearings must be cleaned and the painting of the steel plates repaired if some damages occurred during construction.

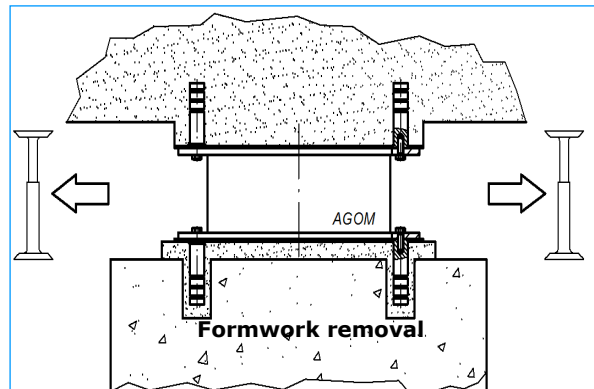

5. Casting of the superstructure - prefabricated superstructure

The bearings normally have upper anchorages that must be inserted into the suitable voids of the prefabricated structure.

After the prefabricated beam has been placed in the final position (the beam must be supported on temporary supports), the bearing upper plate must be surrounded by a seal (normally rubber seal with suitable injection and leakage pipes).

The gap and anchorages voids between plate and beam have to be filled by high strength mortar.

When the mortar has achieved sufficient strength to transmit the weight of the bearings; the temporary supports shall then be removed.

At the end of the construction the bearings must be cleaned and the painting of the steel plates repaired if some damages occurred during construction.

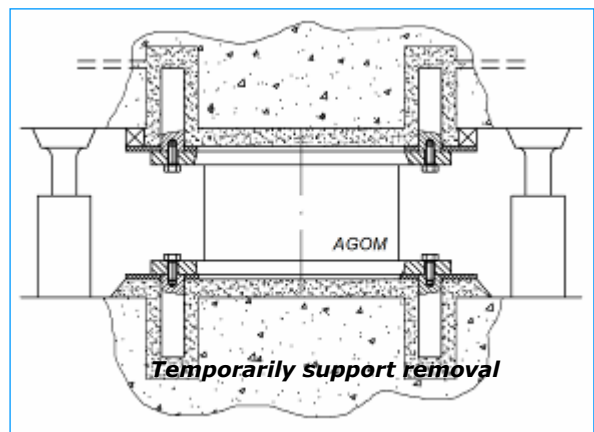
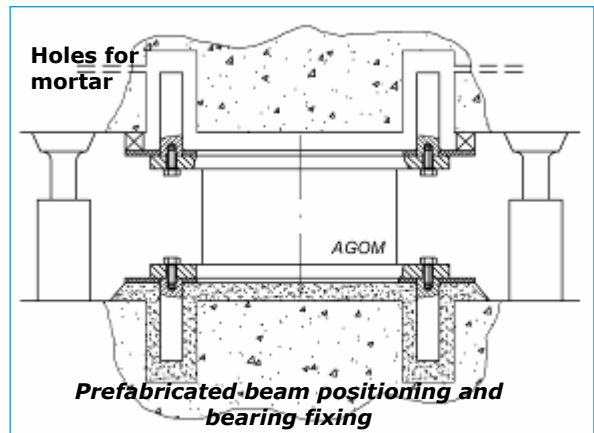

Removal of transport devices

The transport devices, normally painted red should only be removed when the bearing is properly installed and ready for operation.

Any threaded holes exposed after removal of transportation brackets (coloured red) should be sealed with self-vulcanizing silicon sealant.



Maintenance of Bearings

The service life of an elastomeric bearing is usually estimated in more than 50 years.

The most important thing to assure such a long life time is a correct and careful maintenance of the bearing, that is usually installed in a severe environment.

The requested bearing inspection and maintenance program that could be adapted and improved by the Bridge Designer to the specific service conditions of the bridge is fully described in the "Inspection and warranty manual" that can be download from AGOM web site www.agom.it.

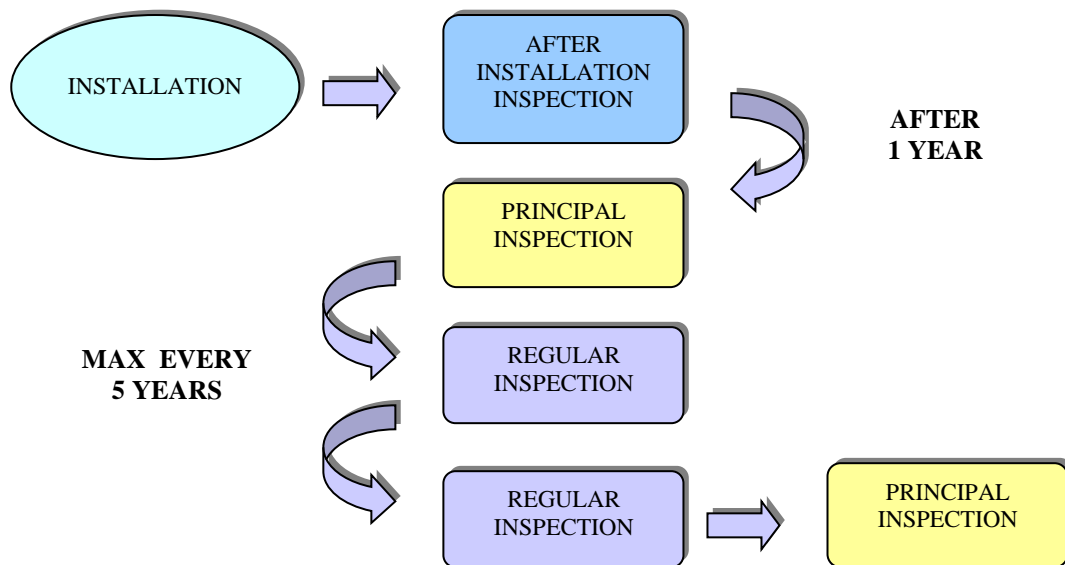

A typical complete routine check of the bearing installed should be comprehensive of the following activities.

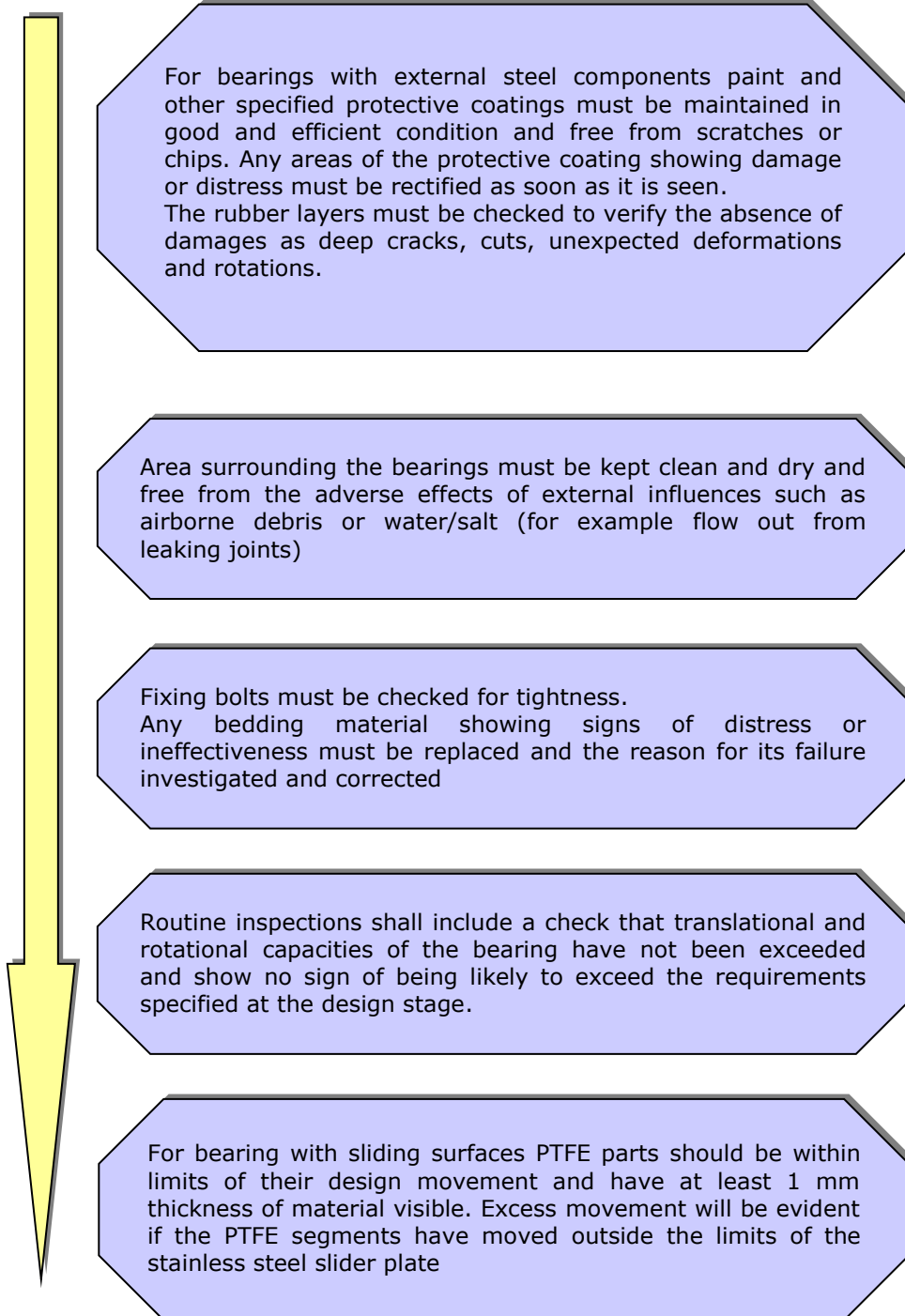

AGOM E-Link bearing combined with anti-lifting system

AGOM E-Link bearings can be equipped with anti-lifting tool in order to absorb the negative tensile vertical forces. The anti-lifting tools can be applied to all the E-Link bearing (fixed, guided and free sliding) with different systems depending on the bearing type and tensile load value.

It is possible to cover a very wide range of tensile loads by suitable design of anti-lifting tools. An example of E-Link bearing combined with anti-lifting devices is shown in the following figure.



AGOM E-Link launching bridge bearings

The launching bearings are normally used for the incremental launching of the prefabricate bridge by sliding it on PTFE bearings into the final position without the aid of scaffolding.

AGOM design and manufacture either temporary elastomeric launching bearings or permanent pot launching bearings that can be act like a normal permanent pot bearing after the launching operation. The construction time of the bridge can be reduced by means of AGOM launching bearings.

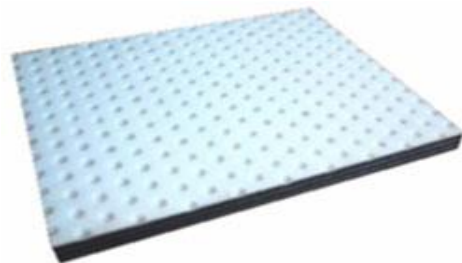

Agom E-Link bearings with holes

Agom can manufacture special bearings with passing holes for post-tensioning bars.



Agom V-Max bearings coupled with E-Link bearing

AGOM V-Max bearing can be equipped with elastic tools in order to provide an elastic horizontal response. The elastic response in the horizontal direction (one or two directions) can be useful for particular applications (example bridge with very high curvature to minimize the parasite effects due to the bearing guide alignments or to equalize the horizontal forces between bearings).

An example of a V-Max bearing combined with elastic tools is shown in the following figure:



AGOM E-Link bearings oversize

AGOM can manufacture elastomeric bearings with plan dimension greater than 1500x3000 mm to withstand even the most non standard technical requirements. In the picture E-Link C3 1200x1200x450 is shown.

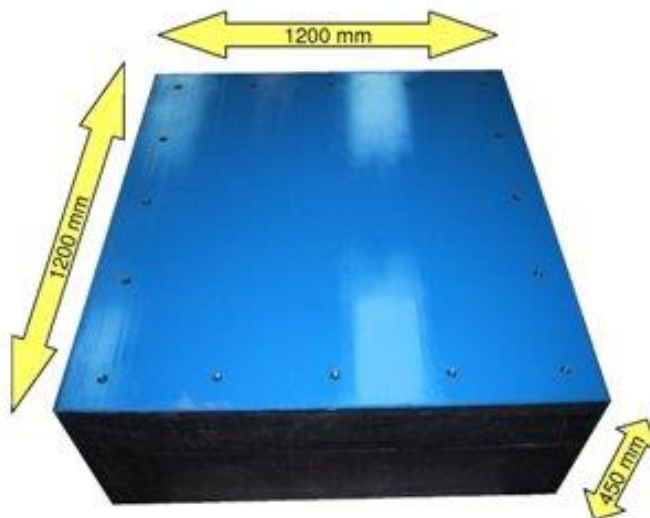

AGOM E-Link design parameters

Normally the required input parameters that the structural Designer has to provide to AGOM Engineers for device design and constructions are the ones shown for example by the table B.1 of EN1337-1 code (attached at the end of this document):

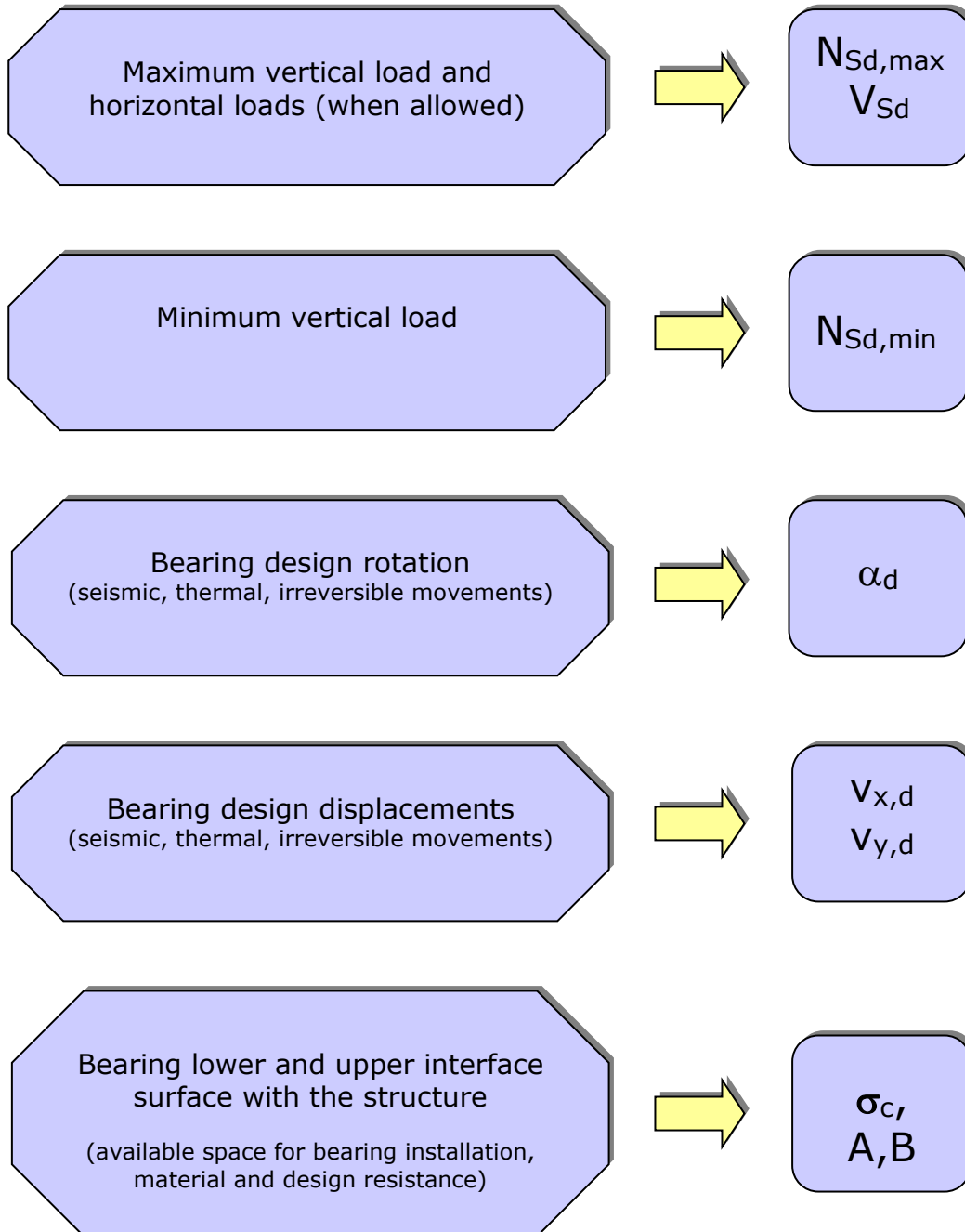

AGOM E-Link standard range

AGOM E-Link bearings can cover a very wide range of loads and displacements, they can be designed according to many international standards (European code **EN 1337**, American **AASHTO LRFD**, British **BS5400**, etc..).

The bearings dimensions shown in the following tables have been designed according to European codes EN 1337-3. Note that the bearing design loads (shown in the tables) are ultimate limit state loads (ULS) according to European codes.

Since the bearings checks depends on the combination of multiple inputs (load, displacement and rotation), AGOM Engineers can assist the structural Designer for design optimisation.

In the following pages, the overall dimensions of a wide range of AGOM E-Link bearings are shown.

AGOM E-Link type B - Standard Bearings with rectangular shape

In this bearing table the following symbols apply:

- a = bearing length (dimension along longitudinal axis)
- b = bearing width (dimension along transversal axis)
- h = bearing total height
- h_{rt} = rubber total height
- W = bearing weight (referred to rubber compound NR60)
- N_{Ed} = design vertical load
- $v_{d,xy}$ = design horizontal displacement
- V_{Ed} = design horizontal load (contemporary to movement)
- α_y = rotation around y axis
- K_h = horizontal stiffness

Bearing type	Bearing dimensions			Rubber Thickness	Weight (*)	ULS	ULS	ULS	ULS	horizontal stiffness
	a	b	h	h_{rt}	W	N_{Ed}	$v_{d,xy} +/-$	V_{Ed}	$\alpha_{d,y} +/-$	K_{eq}
	[mm]	[mm]	[mm]	[mm]	[kg]	[kN]	[mm]	[kN]	[mrad]	[kN/mm]
E-Link B 100x100x14(10)	100	100	14	10	0,35	100	5	9	5,0	0,90
E-Link B 100x100x21(15)	100	100	21	15	0,53	95	10	9	14,0	0,60
E-Link B 100x100x28(20)	100	100	28	20	0,71	70	15	9	25,0	0,45
E-Link B 100x100x35(25)	100	100	35	25	0,89	55	20	9	30,0	0,36
E-Link B 100x100x42(30)	100	100	42	30	1,1	44	25	9	30,0	0,30
E-Link B 100x150x14(10)	100	150	14	10	0,55	190	5	14	5,0	1,4
E-Link B 100x150x21(15)	100	150	21	15	0,82	190	10	14	8,0	0,90
E-Link B 100x150x28(20)	100	150	28	20	1,1	135	15	14	25,0	0,68
E-Link B 100x150x35(25)	100	150	35	25	1,4	105	20	14	30,0	0,54
E-Link B 100x150x42(30)	100	150	42	30	1,6	85	25	14	30,0	0,45
E-Link B 150x200x14(10)	150	200	14	10	1,2	450	5	27	5,0	2,7
E-Link B 150x200x21(15)	150	200	21	15	1,7	480	10	27	8,0	1,8
E-Link B 150x200x28(20)	150	200	28	20	2,3	500	15	27	13,0	1,4
E-Link B 150x200x35(25)	150	200	35	25	2,9	500	20	27	15,0	1,1
E-Link B 150x200x42(30)	150	200	42	30	3,5	470	25	27	18,0	0,90
E-Link B 150x200x49(35)	150	200	49	35	4,0	400	30	27	25,0	0,77
E-Link B 150x200x56(40)	150	200	56	40	4,6	340	35	27	30,0	0,68
E-Link B 150x200x63(45)	150	200	63	45	5,2	290	40	27	30,0	0,60
E-Link B 200x250x19(13)	200	250	19	13	2,8	750	8	45	5,0	3,5
E-Link B 200x250x30(21)	200	250	30	21	4,3	780	16	45	8,0	2,1
E-Link B 200x250x41(29)	200	250	41	29	5,9	850	24	45	9,0	1,6
E-Link B 200x250x52(37)	200	250	52	37	7,4	770	32	45	14,0	1,2
E-Link B 200x250x63(45)	200	250	63	45	8,9	610	40	45	20,0	1,0
E-Link B 200x250x74(53)	200	250	74	53	10,4	500	48	45	30,0	0,85
E-Link B 200x250x85(61)	200	250	85	61	11,9	430	56	45	30,0	0,74
E-Link B 200x300x19(13)	200	300	19	13	3,4	950	8	54	5,0	4,2
E-Link B 200x300x30(21)	200	300	30	21	5,2	1020	16	54	8,0	2,6
E-Link B 200x300x41(29)	200	300	41	29	7,1	1060	24	54	10,0	1,9

E-Link B 200x300x52(37)	200	300	52	37	8,9	1000	32	54	14,0	1,5
E-Link B 200x300x63(45)	200	300	63	45	10,7	810	40	54	20,0	1,2
E-Link B 200x300x74(53)	200	300	74	53	12,5	670	48	54	30,0	1,0
E-Link B 200x300x85(61)	200	300	85	61	14,3	560	56	54	30,0	0,89
E-Link B 200x400x19(13)	200	400	19	13	4,6	1300	8	72	5,0	5,5
E-Link B 200x400x30(21)	200	400	30	21	7,1	1500	16	72	6,0	3,4
E-Link B 200x400x41(29)	200	400	41	29	9,5	1600	24	72	7,0	2,5
E-Link B 200x400x52(37)	200	400	52	37	11,9	1500	32	72	10,0	1,9
E-Link B 200x400x63(45)	200	400	63	45	14,4	1200	40	72	15,0	1,6
E-Link B 200x400x74(53)	200	400	74	53	16,8	1000	48	72	25,0	1,4
E-Link B 200x400x85(61)	200	400	85	61	19,3	850	56	72	30,0	1,2
E-Link B 250x400x19(13)	250	400	19	13	5,8	1500	8	90	4,0	6,9
E-Link B 250x400x30(21)	250	400	30	21	8,9	2100	16	90	6,0	4,3
E-Link B 250x400x41(29)	250	400	41	29	12,0	2300	24	90	7,0	3,1
E-Link B 250x400x52(37)	250	400	52	37	15,1	2300	32	90	8,0	2,4
E-Link B 250x400x63(45)	250	400	63	45	18,2	2300	40	90	10,0	2,0
E-Link B 250x400x74(53)	250	400	74	53	21,2	1900	48	90	16,0	1,7
E-Link B 250x400x85(61)	250	400	85	61	24,3	1600	56	90	25,0	1,5
E-Link B 250x400x96(69)	250	400	96	69	27,4	1400	64	90	30,0	1,3
E-Link B 300x400x19(13)	300	400	19	13	7,0	2400	8	108	3,0	8,3
E-Link B 300x400x30(21)	300	400	30	21	10,8	2700	16	108	5,0	5,1
E-Link B 300x400x41(29)	300	400	41	29	14,5	2800	24	108	7,0	3,7
E-Link B 300x400x52(37)	300	400	52	37	18,2	2900	32	108	8,0	2,9
E-Link B 300x400x63(45)	300	400	63	45	21,9	2800	40	108	10,0	2,4
E-Link B 300x400x74(53)	300	400	74	53	25,7	2800	48	108	12,0	2,0
E-Link B 300x400x85(61)	300	400	85	61	29,4	2700	56	108	15,0	1,8
E-Link B 300x400x96(69)	300	400	96	69	33,1	2400	64	108	20,0	1,6
E-Link B 300x400x107(77)	300	400	107	77	36,8	2100	72	108	27,0	1,4
E-Link B 300x400x118(85)	300	400	118	85	40,5	1900	80	108	30,0	1,3
E-Link B 350x450x24(16)	350	450	24	16	12,2	3100	11	142	3,0	8,9
E-Link B 350x450x39(27)	350	450	39	27	18,8	3500	22	142	5,0	5,3
E-Link B 350x450x54(38)	350	450	54	38	25,4	3800	33	142	5,0	3,7
E-Link B 350x450x69(49)	350	450	69	49	32,0	3800	44	142	6,0	2,9
E-Link B 350x450x84(60)	350	450	84	60	29,9	3700	55	110	7,0	1,8
E-Link B 350x450x99(71)	350	450	99	71	45,3	3100	66	142	15,0	2,0
E-Link B 350x450x114(82)	350	450	114	82	51,9	2700	77	142	20,0	1,7
E-Link B 350x450x129(93)	350	450	129	93	58,5	2300	88	142	27,0	1,5
E-Link B 350x450x144(104)	350	450	144	104	65,1	2000	99	142	30,0	1,4
E-Link B 400x500x24(16)	400	500	24	16	15,5	4100	11	180	3,0	11,3
E-Link B 400x500x39(27)	400	500	39	27	24,0	4700	22	180	4,5	6,7
E-Link B 400x500x54(38)	400	500	54	38	32,4	5000	33	180	6,0	4,7
E-Link B 400x500x69(49)	400	500	69	49	40,9	5000	44	180	7,0	3,7
E-Link B 400x500x84(60)	400	500	84	60	49,3	4800	55	180	10,0	3,0
E-Link B 400x500x99(71)	400	500	99	71	57,8	4700	66	180	12,0	2,5
E-Link B 400x500x114(82)	400	500	114	82	66,3	4600	77	180	14,0	2,2
E-Link B 400x500x129(93)	400	500	129	93	74,7	4000	88	180	20,0	1,9

E-Link B 400x500x144(104)	400	500	144	104	83,2	3500	99	180	26,0	1,7
E-Link B 400x500x159(115)	400	500	159	115	91,6	3100	110	180	30,0	1,6
E-Link B 400x600x24(16)	400	600	24	16	18,7	5000	11	216	3,0	13,5
E-Link B 400x600x39(27)	400	600	39	27	28,9	5600	22	216	5,0	8,0
E-Link B 400x600x54(38)	400	600	54	38	39,0	6000	33	216	6,0	5,7
E-Link B 400x600x69(49)	400	600	69	49	49,2	6000	44	216	8,0	4,4
E-Link B 400x600x84(60)	400	600	84	60	59,4	5800	55	216	10,0	3,6
E-Link B 400x600x99(71)	400	600	99	71	69,6	5700	66	216	13,0	3,0
E-Link B 400x600x114(82)	400	600	114	82	79,8	5500	77	216	16,0	2,6
E-Link B 400x600x129(93)	400	600	129	93	89,9	5200	88	216	18,0	2,3
E-Link B 400x600x144(104)	400	600	144	104	100,1	4500	99	216	25,0	2,1
E-Link B 400x600x159(115)	400	600	159	115	110,3	4000	110	216	28,0	1,9
E-Link B 400x600x174(126)	400	600	174	126	120,5	3600	121	216	28,0	1,7
E-Link B 500x600x24(16)	500	600	24	16	23,5	6500	11	270	2,3	16,9
E-Link B 500x600x39(27)	500	600	39	27	36,3	7400	22	270	4,0	10,0
E-Link B 500x600x54(38)	500	600	54	38	49,0	7600	33	270	6,0	7,1
E-Link B 500x600x69(49)	500	600	69	49	61,8	7700	44	270	7,0	5,5
E-Link B 500x600x84(60)	500	600	84	60	74,6	7400	55	270	9,0	4,5
E-Link B 500x600x99(71)	500	600	99	71	87,4	7400	66	270	12,0	3,8
E-Link B 500x600x114(82)	500	600	114	82	100,2	7300	77	270	14,0	3,3
E-Link B 500x600x129(93)	500	600	129	93	112,9	7100	88	270	16,0	2,9
E-Link B 500x600x144(104)	500	600	144	104	125,7	7000	99	270	18,0	2,6
E-Link B 500x600x159(115)	500	600	159	115	138,5	6900	110	270	20,0	2,3
E-Link B 500x600x174(126)	500	600	174	126	151,3	6800	121	270	21,0	2,1
E-Link B 500x600x189(137)	500	600	189	137	164,1	6200	132	270	25,0	2,0
E-Link B 600x700x30(20)	600	700	30	20	40,9	8600	15	378	3,0	18,9
E-Link B 600x700x50(35)	600	700	50	35	63,8	9500	30	378	5,0	10,8
E-Link B 600x700x70(50)	600	700	70	50	86,7	10800	45	378	6,0	7,6
E-Link B 600x700x90(65)	600	700	90	65	109,5	10700	60	378	7,0	5,8
E-Link B 600x700x110(80)	600	700	110	80	132,4	10500	75	378	9,0	4,7
E-Link B 600x700x130(95)	600	700	130	95	155,3	10200	90	378	11,0	4,0
E-Link B 600x700x150(110)	600	700	150	110	178,1	10000	105	378	13,0	3,4
E-Link B 600x700x170(125)	600	700	170	125	201,0	9800	120	378	16,0	3,0
E-Link B 600x700x190(140)	600	700	190	140	223,9	9300	135	378	18,0	2,7
E-Link B 600x700x210(155)	600	700	210	155	246,8	8300	150	378	25,0	2,4
E-Link B 600x700x230(170)	600	700	230	170	269,6	7400	165	378	30,0	2,2
E-Link B 600x700x250(185)	600	700	250	185	292,5	6700	180	378	30,0	2,0
E-Link B 700x800x30(20)	700	800	30	20	54,9	12000	15	504	2,3	25,2
E-Link B 700x800x50(35)	700	800	50	35	85,5	14000	30	504	4,0	14,4
E-Link B 700x800x70(50)	700	800	70	50	116,2	14700	45	504	5,0	10,1
E-Link B 700x800x90(65)	700	800	90	65	146,8	14500	60	504	7,0	7,8
E-Link B 700x800x110(80)	700	800	110	80	177,5	14200	75	504	9,0	6,3
E-Link B 700x800x130(95)	700	800	130	95	208,1	14000	90	504	11,0	5,3
E-Link B 700x800x150(110)	700	800	150	110	238,7	13800	105	504	13,0	4,6
E-Link B 700x800x170(125)	700	800	170	125	269,4	13600	120	504	15,0	4,0
E-Link B 700x800x190(140)	700	800	190	140	300,0	13400	135	504	17,0	3,6

E-Link B 700x800x210(155)	700	800	210	155	330,7	13200	150	504	19,0	3,3
E-Link B 700x800x230(170)	700	800	230	170	361,3	13000	165	504	20,0	3,0
E-Link B 700x800x250(185)	700	800	250	185	392,0	12600	180	504	22,0	2,7
E-Link B 700x800x270(200)	700	800	270	200	422,6	11500	195	504	27,0	2,5
E-Link B 800x800x33(23)	800	800	33	23	65,1	12800	18	576	2,8	25,0
E-Link B 800x800x56(41)	800	800	56	41	102,4	14800	36	576	4,5	14,0
E-Link B 800x800x79(59)	800	800	79	59	139,7	14800	54	576	6,0	9,8
E-Link B 800x800x102(77)	800	800	102	77	177,0	14700	72	576	8,0	7,5
E-Link B 800x800x125(95)	800	800	125	95	214,3	14500	90	576	11,0	6,1
E-Link B 800x800x148(113)	800	800	148	113	251,6	14200	108	576	13,0	5,1
E-Link B 800x800x171(131)	800	800	171	131	288,9	14200	126	576	15,0	4,4
E-Link B 800x800x194(149)	800	800	194	149	326,2	14000	144	576	17,0	3,9
E-Link B 800x800x217(167)	800	800	217	167	363,5	13800	162	576	19,0	3,4
E-Link B 800x800x240(185)	800	800	240	185	400,8	13600	180	576	21,0	3,1
E-Link B 800x800x263(203)	800	800	263	203	438,1	13500	198	576	23,0	2,8
E-Link B 800x800x286(221)	800	800	286	221	475,5	12200	216	576	27,0	2,6
E-Link B 800x800x309(239)	800	800	309	239	512,8	11200	234	576	30,0	2,4
E-Link B 900x900x33(23)	900	900	33	23	82,6	18000	18	729	2,2	31,7
E-Link B 900x900x56(41)	900	900	56	41	130,0	19200	36	729	4,0	17,8
E-Link B 900x900x79(59)	900	900	79	59	177,4	19000	54	729	6,0	12,4
E-Link B 900x900x102(77)	900	900	102	77	224,7	18800	72	729	8,0	9,5
E-Link B 900x900x125(95)	900	900	125	95	272,1	18600	90	729	10,0	7,7
E-Link B 900x900x148(113)	900	900	148	113	319,5	18400	108	729	12,0	6,5
E-Link B 900x900x171(131)	900	900	171	131	366,8	18200	126	729	14,0	5,6
E-Link B 900x900x194(149)	900	900	194	149	414,2	18000	144	729	16,0	4,9
E-Link B 900x900x217(167)	900	900	217	167	461,6	17800	162	729	18,0	4,4
E-Link B 900x900x240(185)	900	900	240	185	508,9	17600	180	729	20,0	3,9
E-Link B 900x900x263(203)	900	900	263	203	556,3	17400	198	729	22,0	3,6
E-Link B 900x900x286(221)	900	900	286	221	603,7	17200	216	729	24,0	3,3
E-Link B 900x900x309(239)	900	900	309	239	651,0	17000	234	729	26,0	3,1
E-Link B 900x900x332(257)	900	900	332	257	698,4	16800	252	729	28,0	2,8

AGOM E-Link type B - Standard Bearings with circular shape

In this bearing table the following symbols apply:

- D = bearing diameter
- h = bearing total height
- h_{rt} = rubber total height
- W = bearing weight (referred to rubber compound NR60)
- N_{Ed} = design vertical load
- $v_{d,xy}$ = design horizontal displacement
- V_{Ed} = design horizontal load (contemporary to movement)
- $\alpha_{d,xy}$ = rotation around y axis
- K_h = horizontal stiffness

Bearing type	Bearing dimensions		Rubber Thickness	Weight (*)	ULS	ULS	ULS	ULS	horizontal stiffness
	D	h	h_{rt}	W	N_{Ed}	$v_{d,xy} +/-$	V_{Ed}	$\alpha_{d,xy} +/-$	K_{eq}
	[mm]	[mm]	[mm]	[kg]	[kN]	[mm]	[kN]	[mrad]	[kN/mm]
E-Link B Ø200x14(10)	200	14	10	1,2	600	5	14	4,0	2,8
E-Link B Ø200x21(15)	200	21	15	1,8	600	10	19	7,0	1,9
E-Link B Ø200x28(20)	200	28	20	2,5	630	15	21	10,0	1,4
E-Link B Ø200x35(25)	200	35	25	3,1	650	20	23	11,0	1,1
E-Link B Ø200x42(30)	200	42	30	3,7	670	25	24	12,0	0,94
E-Link B Ø200x49(35)	200	49	35	4,3	670	30	24	13,0	0,81
E-Link B Ø200x56(40)	200	56	40	4,9	670	35	25	14,0	0,71
E-Link B Ø250x19(13)	250	19	13	2,8	700	8	27	7,0	3,4
E-Link B Ø250x30(21)	250	30	21	4,3	900	16	34	8,0	2,1
E-Link B Ø250x41(29)	250	41	29	5,8	900	24	37	10,0	1,5
E-Link B Ø250x52(37)	250	52	37	7,3	900	32	38	12,0	1,2
E-Link B Ø250x63(45)	250	63	45	8,8	900	40	39	15,0	1,0
E-Link B Ø250x74(53)	250	74	53	10,3	800	48	40	20,0	0,83
E-Link B Ø250x85(61)	250	85	61	11,8	680	56	41	22,0	0,72
E-Link B Ø250x96(69)	250	96	69	13,3	580	64	41	22,0	0,64
E-Link B Ø300x19(13)	300	19	13	4,1	1200	8	39	5,0	4,9
E-Link B Ø300x30(21)	300	30	21	6,3	1300	16	48	9,0	3,0
E-Link B Ø300x41(29)	300	41	29	8,5	1500	24	53	10,0	2,2
E-Link B Ø300x52(37)	300	52	37	10,6	1600	32	55	11,0	1,7
E-Link B Ø300x63(45)	300	63	45	12,8	1600	40	57	11,0	1,4
E-Link B Ø300x74(53)	300	74	53	15,0	1600	48	58	12,0	1,2
E-Link B Ø300x85(61)	300	85	61	17,2	1500	56	58	15,0	1,0
E-Link B Ø300x96(69)	300	96	69	19,3	1300	64	59	20,0	0,92
E-Link B Ø300x107(77)	300	107	77	21,5	1100	72	59	25,0	0,83
E-Link B Ø300x118(85)	300	118	85	23,7	990	80	60	28,0	0,75
E-Link B Ø350x24(16)	350	24	16	7,4	1800	11	60	5,0	5,4
E-Link B Ø350x39(27)	350	39	27	11,4	1900	22	71	7,0	3,2
E-Link B Ø350x54(38)	350	54	38	15,4	2000	33	75	8,0	2,3
E-Link B Ø350x69(49)	350	69	49	19,4	2000	44	78	9,0	1,8

E-Link B Ø350x84(60)	350	84	60	23,5	1900	55	79	10,0	1,4
E-Link B Ø350x99(71)	350	99	71	27,5	1700	66	80	15,0	1,2
E-Link B Ø350x114(82)	350	114	82	31,5	1400	77	81	20,0	1,1
E-Link B Ø350x129(93)	350	129	93	35,5	1200	88	82	27,0	0,93
E-Link B Ø350x144(104)	350	144	104	39,6	1100	99	82	30,0	0,83
E-Link B Ø400x24(16)	400	24	16	9,7	2300	11	78	5,0	7,1
E-Link B Ø400x39(27)	400	39	27	15,0	2700	22	92	7,0	4,2
E-Link B Ø400x54(38)	400	54	38	20,3	2800	33	98	8,0	3,0
E-Link B Ø400x69(49)	400	69	49	25,6	2800	44	102	10,0	2,3
E-Link B Ø400x84(60)	400	84	60	30,9	2900	55	104	10,0	1,9
E-Link B Ø400x99(71)	400	99	71	36,1	2900	66	105	10,0	1,6
E-Link B Ø400x114(82)	400	114	82	41,4	2600	77	106	16,0	1,4
E-Link B Ø400x129(93)	400	129	93	46,7	2200	88	107	22,0	1,2
E-Link B Ø400x144(104)	400	144	104	52,0	1900	99	108	26,0	1,1
E-Link B Ø400x159(115)	400	159	115	57,3	1700	110	108	30,0	1,0
E-Link B Ø400x174(126)	400	174	126	62,6	1500	121	109	30,0	0,90
E-Link B Ø450x24(16)	450	24	16	12,4	3200	11	98	4,5	8,9
E-Link B Ø450x39(27)	450	39	27	19,1	3600	22	117	7,0	5,3
E-Link B Ø450x54(38)	450	54	38	25,8	3900	33	124	8,0	3,8
E-Link B Ø450x69(49)	450	69	49	32,5	3900	44	129	10,0	2,9
E-Link B Ø450x84(60)	450	84	60	39,3	4100	55	131	10,0	2,4
E-Link B Ø450x99(71)	450	99	71	46,0	4100	66	133	10,0	2,0
E-Link B Ø450x114(82)	450	114	82	52,7	4100	77	134	10,0	1,7
E-Link B Ø450x129(93)	450	129	93	59,4	3700	88	135	16,0	1,5
E-Link B Ø450x144(104)	450	144	104	66,2	3300	99	136	22,0	1,4
E-Link B Ø450x159(115)	450	159	115	72,9	2900	110	137	26,0	1,2
E-Link B Ø450x174(126)	450	174	126	79,6	2600	121	137	30,0	1,1
E-Link B Ø500x24(16)	500	24	16	15,3	4300	11	121	3,5	11,0
E-Link B Ø500x39(27)	500	39	27	23,7	4700	22	144	6,0	6,5
E-Link B Ø500x54(38)	500	54	38	32,0	5000	33	153	8,0	4,7
E-Link B Ø500x69(49)	500	69	49	40,3	5000	44	159	10,0	3,6
E-Link B Ø500x84(60)	500	84	60	48,7	5300	55	162	10,0	2,9
E-Link B Ø500x99(71)	500	99	71	57,0	5400	66	164	11,0	2,5
E-Link B Ø500x114(82)	500	114	82	65,4	5400	77	166	12,0	2,2
E-Link B Ø500x129(93)	500	129	93	73,7	5300	88	167	13,0	1,9
E-Link B Ø500x144(104)	500	144	104	82,0	5200	99	168	15,0	1,7
E-Link B Ø500x159(115)	500	159	115	90,4	4600	110	169	18,0	1,5
E-Link B Ø500x174(126)	500	174	126	98,7	4100	121	170	22,0	1,4
E-Link B Ø500x189(137)	500	189	137	107,0	3700	132	170	26,0	1,3
E-Link B Ø500x204(148)	500	204	148	115,4	3300	143	171	30,0	1,2
E-Link B Ø550x24(16)	550	24	16	18,6	5800	11	147	3,0	13,4
E-Link B Ø550x39(27)	550	39	27	28,7	6000	22	174	5,5	7,9
E-Link B Ø550x54(38)	550	54	38	38,9	6000	33	186	8,0	5,6
E-Link B Ø550x69(49)	550	69	49	49,0	6200	44	192	10,0	4,4
E-Link B Ø550x84(60)	550	84	60	59,1	6700	55	196	10,0	3,6
E-Link B Ø550x99(71)	550	99	71	69,2	6700	66	199	11,5	3,0

E-Link B Ø550x114(82)	550	114	82	79,3	6700	77	201	13,0	2,6
E-Link B Ø550x129(93)	550	129	93	89,5	6500	88	202	15,0	2,3
E-Link B Ø550x144(104)	550	144	104	99,6	6500	99	204	16,0	2,1
E-Link B Ø550x159(115)	550	159	115	109,7	6400	110	205	18,0	1,9
E-Link B Ø550x174(126)	550	174	126	119,8	6100	121	205	21,0	1,7
E-Link B Ø550x189(137)	550	189	137	130,0	5500	132	206	26,0	1,6
E-Link B Ø550x204(148)	550	204	148	140,1	5000	143	207	30,0	1,4
E-Link B Ø600x30(20)	600	30	20	27,8	6200	15	191	4,0	12,7
E-Link B Ø600x50(35)	600	50	35	43,3	6400	30	218	7,0	7,3
E-Link B Ø600x70(50)	600	70	50	58,8	6500	45	229	10,0	5,1
E-Link B Ø600x90(65)	600	90	65	74,3	6900	60	235	10,0	3,9
E-Link B Ø600x110(80)	600	110	80	89,8	7200	75	239	10,0	3,2
E-Link B Ø600x130(95)	600	130	95	105,3	7300	90	241	10,0	2,7
E-Link B Ø600x150(110)	600	150	110	120,8	7100	105	243	12,0	2,3
E-Link B Ø600x170(125)	600	170	125	136,3	6600	120	244	16,0	2,0
E-Link B Ø600x190(140)	600	190	140	151,8	5800	135	245	25,0	1,8
E-Link B Ø600x210(155)	600	210	155	167,3	5000	150	246	30,0	1,6
E-Link B Ø600x230(170)	600	230	170	182,8	4500	165	247	30,0	1,5
E-Link B Ø650x30(20)	650	30	20	32,7	7100	15	224	3,8	14,9
E-Link B Ø650x50(35)	650	50	35	50,9	7400	30	256	7,0	8,5
E-Link B Ø650x70(50)	650	70	50	69,1	7600	45	269	10,0	6,0
E-Link B Ø650x90(65)	650	90	65	87,4	8400	60	276	10,0	4,6
E-Link B Ø650x110(80)	650	110	80	105,6	8800	75	280	10,0	3,7
E-Link B Ø650x130(95)	650	130	95	123,9	8600	90	283	12,0	3,1
E-Link B Ø650x150(110)	650	150	110	142,1	8500	105	285	14,0	2,7
E-Link B Ø650x170(125)	650	170	125	160,4	8300	120	287	16,0	2,4
E-Link B Ø650x190(140)	650	190	140	178,6	8000	135	288	18,0	2,1
E-Link B Ø650x210(155)	650	210	155	196,8	7200	150	289	25,0	1,9
E-Link B Ø650x230(170)	650	230	170	215,1	6400	165	290	30,0	1,8
E-Link B Ø700x30(20)	700	30	20	37,6	8700	15	260	3,4	17,3
E-Link B Ø700x50(35)	700	50	35	58,6	9000	30	297	6,6	9,9
E-Link B Ø700x70(50)	700	70	50	79,6	9200	45	312	9,0	6,9
E-Link B Ø700x90(65)	700	90	65	100,7	10000	60	320	10,0	5,3
E-Link B Ø700x110(80)	700	110	80	121,7	10300	75	325	11,0	4,3
E-Link B Ø700x130(95)	700	130	95	142,7	10000	90	328	14,0	3,6
E-Link B Ø700x150(110)	700	150	110	163,7	9900	105	331	16,0	3,1
E-Link B Ø700x170(125)	700	170	125	184,7	9600	120	333	19,0	2,8
E-Link B Ø700x190(140)	700	190	140	205,7	9600	135	334	21,0	2,5
E-Link B Ø700x210(155)	700	210	155	226,8	9500	150	335	22,0	2,2
E-Link B Ø700x230(170)	700	230	170	247,8	8800	165	336	26,0	2,0
E-Link B Ø700x250(185)	700	250	185	268,8	8000	180	337	30,0	1,9
E-Link B Ø700x270(200)	700	270	200	289,8	7200	195	338	30,0	1,7
E-Link B Ø750x30(20)	750	30	20	43,3	11000	15	298	3,0	19,9
E-Link B Ø750x50(35)	750	50	35	67,5	11700	30	341	5,0	11,4
E-Link B Ø750x70(50)	750	70	50	91,6	12000	45	358	7,0	8,0
E-Link B Ø750x90(65)	750	90	65	115,8	12000	60	367	9,0	6,1

E-Link B Ø750x110(80)	750	110	80	140,0	11900	75	373	10,0	5,0
E-Link B Ø750x130(95)	750	130	95	164,2	11700	90	377	13,0	4,2
E-Link B Ø750x150(110)	750	150	110	188,4	11400	105	380	16,0	3,6
E-Link B Ø750x170(125)	750	170	125	212,6	11400	120	382	18,0	3,2
E-Link B Ø750x190(140)	750	190	140	236,7	11200	135	383	20,0	2,8
E-Link B Ø750x210(155)	750	210	155	260,9	11000	150	385	22,0	2,6
E-Link B Ø750x230(170)	750	230	170	285,1	10800	165	386	25,0	2,3
E-Link B Ø750x250(185)	750	250	185	309,3	10700	180	387	26,0	2,1
E-Link B Ø750x270(200)	750	270	200	333,5	9700	195	388	30,0	2,0
E-Link B Ø800x33(23)	800	33	23	51,1	11200	18	354	3,7	19,7
E-Link B Ø800x56(41)	800	56	41	80,4	11700	36	397	6,5	11,0
E-Link B Ø800x79(59)	800	79	59	109,7	11600	54	414	10,0	7,7
E-Link B Ø800x102(77)	800	102	77	139,0	11400	72	423	13,0	5,9
E-Link B Ø800x125(95)	800	125	95	168,3	11200	90	429	16,0	4,8
E-Link B Ø800x148(113)	800	148	113	197,6	11000	108	432	19,0	4,0
E-Link B Ø800x171(131)	800	171	131	226,9	10800	126	435	22,0	3,5
E-Link B Ø800x194(149)	800	194	149	256,2	10600	144	437	25,0	3,0
E-Link B Ø800x217(167)	800	217	167	285,5	10400	162	439	28,0	2,7
E-Link B Ø800x240(185)	800	240	185	314,8	10200	180	440	30,0	2,4
E-Link B Ø800x263(203)	800	263	203	344,1	10000	198	441	30,0	2,2
E-Link B Ø800x286(221)	800	286	221	373,4	9400	216	442	30,0	2,0
E-Link B Ø800x309(239)	800	309	239	402,7	8600	234	443	30,0	1,9
E-Link B Ø900x33(23)	900	33	23	64,9	15000	18	448	2,9	24,9
E-Link B Ø900x56(41)	900	56	41	102,1	15000	36	503	5,8	14,0
E-Link B Ø900x79(59)	900	79	59	139,3	14700	54	524	8,6	9,7
E-Link B Ø900x102(77)	900	102	77	176,5	14500	72	535	11,0	7,4
E-Link B Ø900x125(95)	900	125	95	213,7	14300	90	542	13,5	6,0
E-Link B Ø900x148(113)	900	148	113	250,9	14100	108	547	16,5	5,1
E-Link B Ø900x171(131)	900	171	131	288,1	13900	126	551	19,0	4,4
E-Link B Ø900x194(149)	900	194	149	325,3	13700	144	553	21,0	3,8
E-Link B Ø900x217(167)	900	217	167	362,5	13500	162	555	23,5	3,4
E-Link B Ø900x240(185)	900	240	185	399,7	13300	180	557	25,5	3,1
E-Link B Ø900x263(203)	900	263	203	436,9	13100	198	558	28,0	2,8
E-Link B Ø900x286(221)	900	286	221	474,1	12900	216	560	30,0	2,6
E-Link B Ø900x309(239)	900	309	239	511,3	12700	234	561	30,0	2,4
E-Link B Ø900x332(257)	900	332	257	548,5	12500	252	561	30,0	2,2

Bearing design table according to EN1337-1 code

The purpose of this bridge bearing schedule is to list the information normally required for the design of the bearings for a particular structure. This information should ensure that bearings are designed and manufactured so that, under the influence of all possible actions, unfavourable effects of the bearing on the structure are avoided. A drawing should accompany the schedule showing the layout of the bearings with identification marks, including a typical cross section of the bridge and particular of any special locating requirements. Bearing function should be indicated on the drawing by appropriate symbols.

Every item listed in the “bearing design table” should be considered, but some may not be applicable to a particular bearing. Only relevant information should be given and when an item in the schedule is not applicable this should be stated. Additional information should be added when special conditions exist.

Here above you can find a short explanation of each item listed in the “bearing design table”

BEARING IDENTIFICATION MARK	Bearing with different function or load carrying requirements should be distinguished by a unique reference mark
NUMBER OFF	The required number for each item
SEATING MATERIAL	The materials on which each outer bearing plate bears should be stated as it may affect the design and finish of these plates
AVERAGE DESIGN CONTACT PRESSURE	The pressure of the effective contact area
DESIGN LOAD AFFECTS	The structure designer should give the worst individual values of the design load effects in the schedule. The most adverse combination of these values is usually sufficient for a satisfactory design of bearing. Only in special cases would greater economy be achieved by considering the actual coexistent values of load effects, in which case these should be given in detail.
DISPLACEMENT	Displacement of the structure at a bearing should be determined and factored. Allowance should be made for any movement of the supporting structures. Transverse and longitudinal movements are normally in a direction perpendicular and parallel to the longitudinal axis of a bridge span, respectively. Where there is any likelihood of ambiguity directions of movement should be clearly indicated on the accompanying drawing.

<p>ROTATION</p>	<p>The irreversible and reversible rotations at the serviceability limit state (SLS), which the bearing is required to accommodate, should be given in radians.</p> <p>In the case of elastomeric bearings the maximum rate should be given: $100 \times (\text{rotation [rad]}/\text{coexisting design vertical load [kN]})$</p>
<p>MAXIMUM BEARING DIMENSIONS</p>	<p>The maximum sizes of the bearing that can be accommodated should be stated</p>
<p>TOLERABLE MOVEMENT OF BEARING UNDER TRANSIENT LOADS</p>	<p>The movement that can be tolerated at the bearing under transient loads, in directions in which the bearing is meant to provide restraint</p>
<p>ALLOWABLE RESISTANCE TO TRASLATION UNDER SLS [kN] <i>(if relevant)</i></p>	<p>In the design of the structure, reaction to displacement movements may be of significance, in which case the acceptable horizontal force generated by the bearing should be given for the serviceability limit state (SLS). The values to be given are those for slowly applied movements at normal temperatures (any necessary extra allowance for low temperatures and rapidly applied movements should be made by the designer of the structure).</p>
<p>ALLOWABLE RESISTANCE TO ROTATION UNDER SLS [kN*m] <i>(if relevant)</i></p>	<p>In the design of the structure, reaction to rotation may be of significance in which case the acceptable moment of reaction generated by the bearing, when subjected to the critical design load effects, should be given for the serviceability design state.</p>
<p>TYPE OF FIXING REQUIRED</p>	<p>Various means of fixing the bearing to the superstructure and substructure are available, appropriate to different type of bearing. Particular requirements, such as friction, bolts, dowels, keys or other devices, should be stated.</p>

Bearing Design Table

Reference:..... Date:.....

Bridge Name: Table: of

BEARING IDENTIFICATION MARK							
NUMBER OFF							
SEATING MATERIAL (e.g. cement, mortar, epoxy mortar, in situ concrete, precast concrete, steel, timber)	Upper surface						
	Lower surface						
AVERAGE DESIGN CONTACT PRESSURE [N/mm ²]	Upper face	SLS					
		ULS					
	Lower face	SLS					
		ULS					
DESIGN LOAD EFFECTS [kN]	ULS	vertical	Max				
			Permanent				
			Min.				
		Transverse					
	Longitudinal						
	SLS	Vertical					
		Transverse					
		Longitudinal					
DISPLACEMENT [mm]	ULS	Transverse					
		Longitudinal					
	SLS	Transverse					
		Longitudinal					
ROTATION	ULS	Transverse					
		Longitudinal					
MAXIMUM BEARING DIMENSIONS [mm]	Transverse						
	Longitudinal						
	Overall Height						
TOLERABLE MOVEMENT OF BEARING UNDER TRANSIENT LOADS [mm] <i>(if relevant)</i>	Vertical						
	Transverse						
	Longitudinal						
ALLOWABLE RESISTANCE TO TRASLATION UNDER SLS [kN] <i>(if relevant)</i>	Transverse						
	Longitudinal						
ALLOWABLE RESISTANCE TO ROTATION UNDER SLS [kN·m] <i>(if relevant)</i>	Transverse						
	Longitudinal						
TYPE OF FIXING REQUIRED	Upper face						
	Lower face						

MORE THAN 50 YEARS EXPERIENCE DESIGNING AND MANUFACTURING DEVICES FOR CONSTRUCTION, OFFSHORE AND INDUSTRIAL MARKETS



Bridge bearings

- Elastomeric Bridge bearings
- Pot bearings
- Spherical bearings
- Incremental Launching bearings
- Horizontal load bearings
- Special bearings

Seismic Isolators

- High damping rubber bearings
- Lead core rubber bearings
- Multilayer rubber bearings
- Shock transmitters
- Shock absorber
- Rubber dampers

Expansion joints

- Elastomeric joints
- Joints for high movements
- Finger joints
- Buried joints
- Railway joints

Services

- Design
- Consulting
- On site assistance
- Installations
- Tests
- Inspection

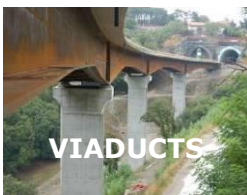

AGOM INTERNATIONAL SRL con Socio Unico Via Mesero, 12 –
20010 Ossona (MI) - Italy
Tel.: +39 02 9029111–FAX: +39 02 9010201 www.agom.it - e-mail: agom@agom.it



UNI EN ISO 9001:2015



SISTEMA DI GESTIONE
QUALITÀ CERTIFICATO



CERTIQUALITY
È MEMBRO DELLA
FEDERAZIONE CISQ

